

*Fábrica de parasoles / Parasol manufacturer /  
Usine de parasols*

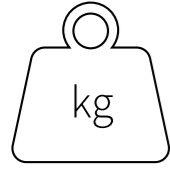

catálogo  
catalogue

EDITION n°  
**32**  
2023-2024



**Peso aprox**  
Approx. weight  
Poids approx



**Ruedas opcionales** Optional  
wheels Roues optionnelles

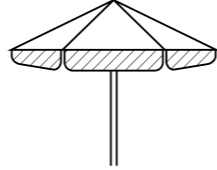

**Volante**  
Valance  
Volant



**Caja de conexión**  
Connection box  
Boîte de jonction

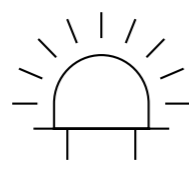

**Iluminación LED**  
LED light  
Éclairage LED



**Calefacción por infrarrojos** Infrared heater  
Chauffage infrarouge

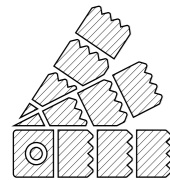

**Colores de tejido**  
Fabric colors  
Tissu couleurs

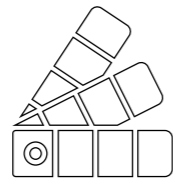

**Colores para la montura** Frame colors  
Couleurs monture

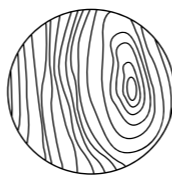

**Imitación madera**  
Wood imitation  
Imitation bois.

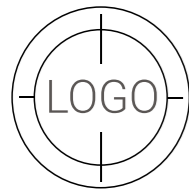

**Estampado**  
Printing  
Estampage

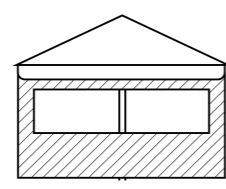

**Cerramientos laterales** Side screens  
Bâches latérales

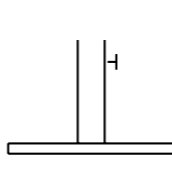

**Bases**  
Bases  
Bases

# INDEX

Parasol de aluminio / Aluminium parasol / Parasol en aluminium	
Serie ESTANDAR	8
Serie ESTANDAR EXTRA	12
Serie ELITE	16
Serie ELITE TELESCÓPICO	20
Serie ELITE PLUS	24
Serie ELITE DESPLAZADO	28
Serie PALMA	32
Serie PALMA DESPLAZADO	36
Serie BERLIN	40
Serie BERLIN DESPLAZADO	44
Parasol de madera / Wood parasol / Parasol en bois	
Serie NATURFUST	6
Serie GOLD EXTRA	48
Serie LUXE	50
Serie CLASSIC	52
Serie NIZA	54
Serie BASIC	56
Serie POOL MADERA	58
Quick service	
Serie POOL	60
Serie SINTRA	61
Serie STREET	62
Accesorios y acabados / Accessories and finishes / Accessoires et finitions	
Bases parasol / Parasol bases / Bases parasols	64
Iluminación / Lighting / Éclairage	70
Calefacción / Heating / Chauffage	74
Fundas parasol / Parasol cases / Housses parasol	75
Cerramientos laterales / Side screens / Bâches latérales	76
Separadores / Fences / Séparateurs	78
Colores estructura / Frame colors / Couleurs monture	68
Estampación textil / Textile printing / Estampage textile	82
Faldón luminoso / Lighting volant / Volant lumineux	83
Tejidos / Fabrics / Tissus	84

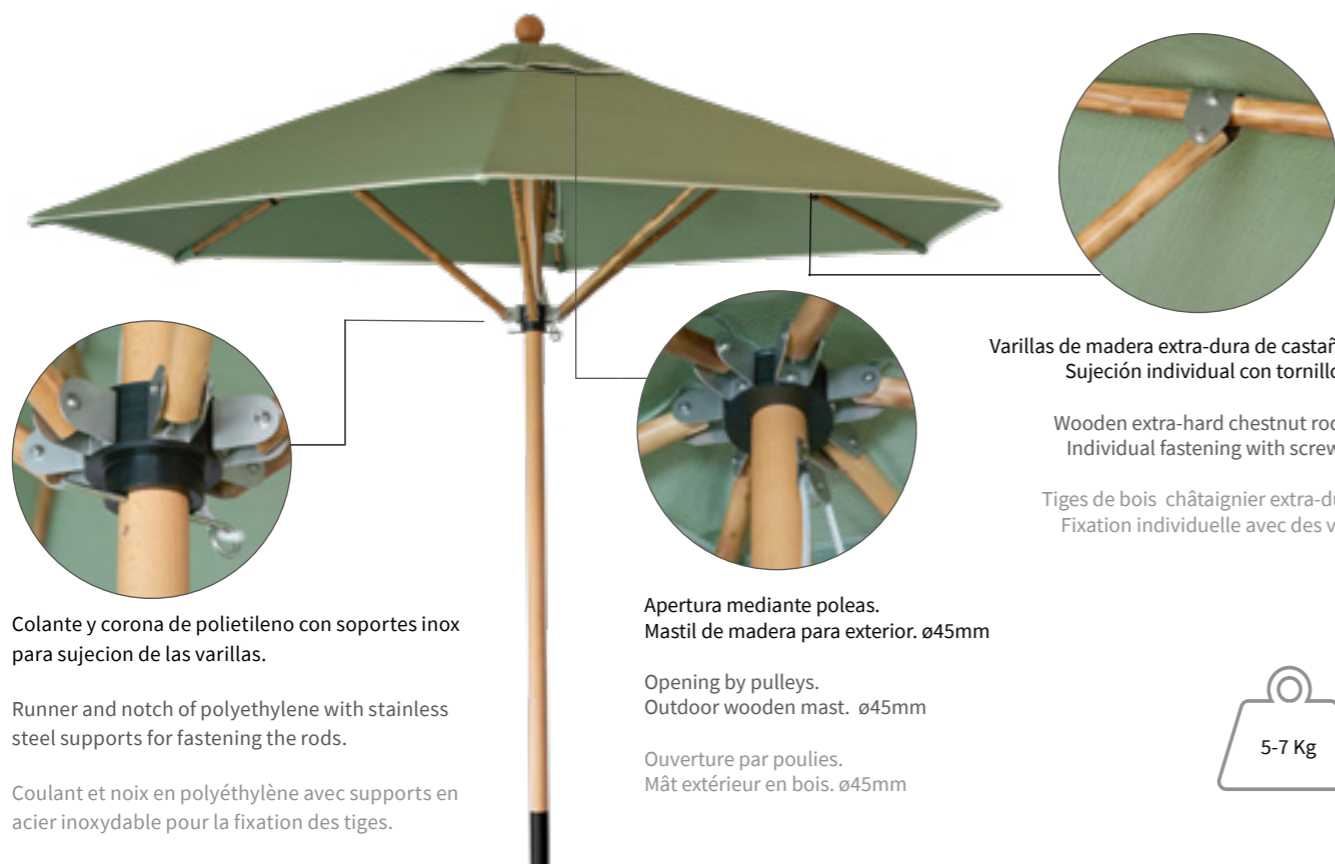

Colante y corona de polietileno con soportes inox para sujeción de las varillas.

Runner and notch of polyethylene with stainless steel supports for fastening the rods.

Coulant et noix en polyéthylène avec supports en acier inoxydable pour la fixation des tiges.

Apertura mediante poleas.  
Mastil de madera para exterior. ø45mm

Opening by pulleys.  
Outdoor wooden mast. ø45mm

Ouverture par poulies.  
Mât extérieur en bois. ø45mm

Varillas de madera extra-dura de castaño.  
Sujeción individual con tornillos.

Wooden extra-hard chestnut rods.  
Individual fastening with screws.

Tiges de bois châtaignier extra-dur.  
Fixation individuelle avec des vis.



5-7 Kg

NOVEDAD

# SERIE NATURFUST

Parasol de madera  
Wood parasol  
Parasol en bois

ES

Varillaje especial de madera de castaño extra dura prácticamente irrompible por uso ordinario. Fabricado artesanalmente, resulta adecuado para hostelería de montaña, terrazas de calles peatonales y jardines particulares, donde se puede apreciar el valor de la elaboración artesanal.

EN

Special extra hard chestnut wood ribs practically unbreakable by ordinary use. Handcrafted, it is suitable for mountain hotels, pedestrian street terraces and private gardens, where you can appreciate the value of craftsmanship.

FR

Baleines en bois de châtaignier extra dur pratiquement incassables par un usage ordinaire. Fabriqué à la main, il convient aux hôtels de montagne, aux terrasses des rues piétonnes et aux jardins privés, où vous pourrez apprécier la valeur de l'artisanat.

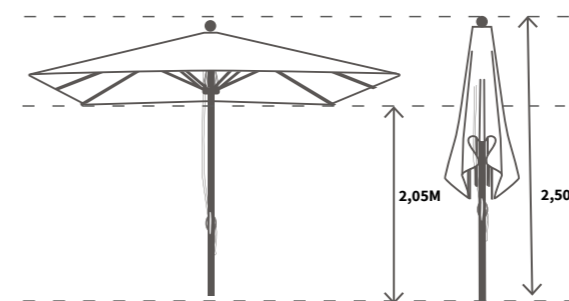

Se presenta con el tejido **FLORIDA**, fabricado con dos hilos de distinto color, formando una estructura flexible y resistente.

It is presented with the **FLORIDA** fabric, made with two threads of different colors, forming a flexible and resistant structure.

Il est présenté avec le tissu **FLORIDA**, composé de deux fils de couleurs différentes, formant une structure souple et résistante.

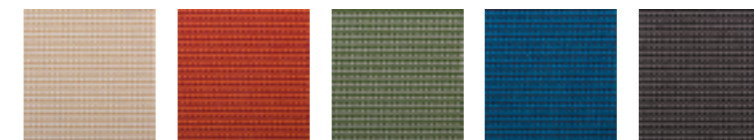

80% protección UV  
Teflon  
Water repellent

Medidas  
Sizes  
Measures

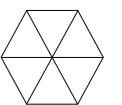

2m / 2,5m / 3m

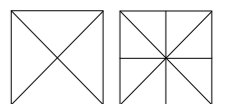

2x2m

2,5x2,5m

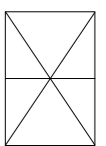

2x2,5m



# SERIE ESTANDAR

**Parasol de aluminio**  
Aluminium parasol  
Parasol en aluminium

## ES

Parasol ligero y de dimensiones reducidas una vez cerrado. Esto permite que sea fácil de manejar y práctico para terrazas que se deben recoger a diario.

## EN

Lightweight and compact parasol once closed. This makes it easy to handle for terraces that have to be picked up every day.

## FR

Parasol léger et compact une fois fermé. Cela le rend facile à manipuler et pratique pour les terrasses qui doivent ramasser les parasols tous les jours.

Mástil **NO telescópico** Apertura **POLEAS**  
Pole **NOT telescopic** Opening **PULLEYS**  
Mât **NON télescopique** Ouverture **POULIES**

## Opciones / Options / Options

Acabados  
Finishes  
Finitions

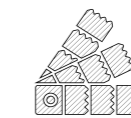

ref **TPA/TOP/TAS**  
p. 84-87

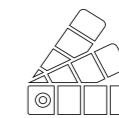

p.80



p.10



p.82

Accesorios  
Accessories  
Accessoires

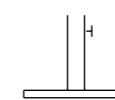

p.64-69

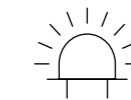

p.70-73

## Características / Features / Caractéristiques

SERIE  
ESTANDAR

Mástil de aluminio lacado blanco.  
Colante y corona de plástico blanco.

White coated aluminium frame.  
White plastic runner and notch.

Mât en aluminium laqué blanc.  
Coulant et noix en plastique blanc.



Mástil de aluminio anodizado gris.  
Colante y corona de plástico gris.

Anodized grey aluminium frame.  
Grey plastic runner and notch.

Mât en aluminium anodisé gris.  
Coulant et noix en plastique gris.



Mástil de ø50mm (1,5mm de grosor).  
Sistema de apertura mediante dos poleas.

ø50mm pole(1,5mm thickness).  
Opening system by two pulleys.

Mât ø50mm(1,5mm d'épaisseur).  
Système d'ouverture par deux poulies.

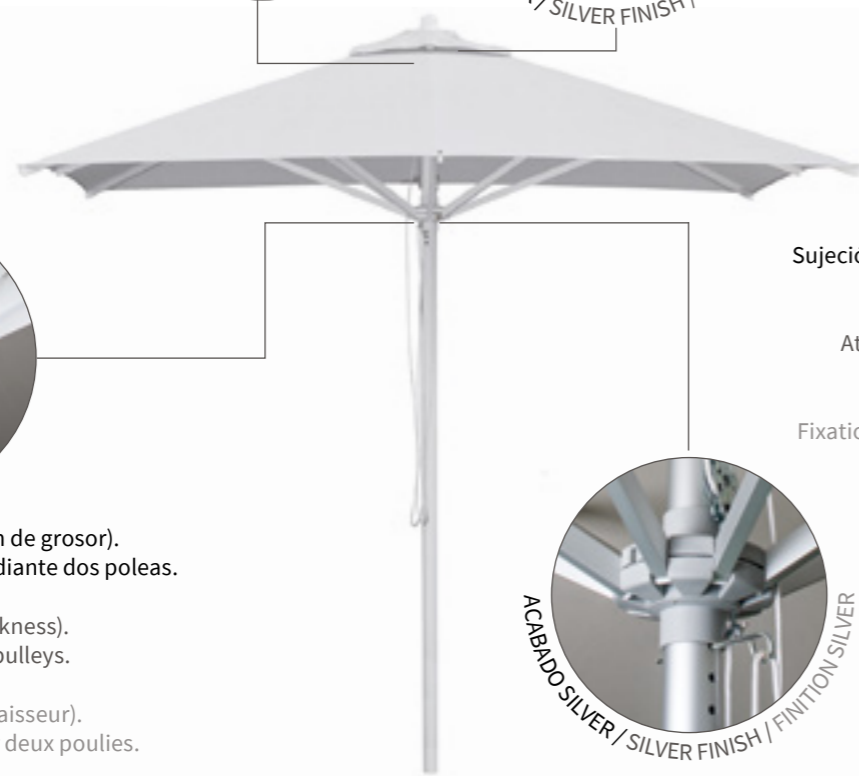

Varillas perfil 15x25 mm.  
Sujeción conjunta por alambre.

Section 15x25mm ribs.  
Attached together by wire.

Profile 15x25mm.  
Fixation conjointe par fil de fer.



## Bases recomendadas / Suggested bases / Bases recommandées



Metallica 65-6  
Metallic 65-6  
Metallique 65-6



Hormigón recubierto y ruedas  
Coated concrete and wheels  
Béton enduit et roues



Bases para empotrar  
Built in bases  
Bases à encaster



Fijar 10  
Fix 10  
Fixer 10

TODAS LAS  
BASES /

ALL BASES /

TOUTES  
BASES

— p.64

## Tabla de medidas / Available sizes / Tableau de mesures

SERIE  
ESTANDAR

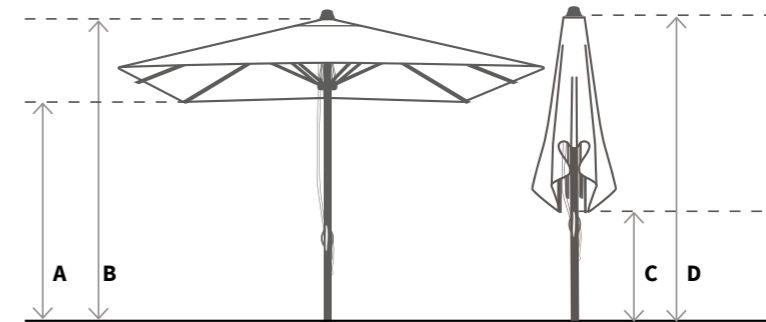

**A-** Altura varilla abierto  
Rib height open  
Hauteur baleine ouvert

**B-** Altura parasol abierto  
Open parasol height  
Hauteur parasol ouvert

**C-** Altura varilla cerrado  
Rib height closed  
Hauteur baleine fermé

**D-** Altura parasol cerrado  
Closed parasol height  
Hauteur parasol fermé

forma shape forme	medida measurement dimension	varillas ribs baleines	mástil pole mât	altura A height A hauteur A	altura B height B hauteur B	altura C height C hauteur C	altura D height D hauteur D	embalaje packaging emballage
	2m	8	Ø50mm	186cm	242cm	136cm	242cm	23x23x245cm
	2'4m	8	Ø50mm	196cm	250cm	124cm	250cm	23x23x250cm
	3m	8	Ø50mm	190cm	250cm	93cm	250cm	23x23x250cm
	3'5m	8	Ø50mm	187cm	250cm	69cm	250cm	23x23x250cm
	4m	8	Ø50mm	219cm	275cm	69cm	275cm	23x23x275cm

	2x2m	8	Ø50mm	210cm	250cm	118cm	250cm	23x23x250cm
	2'4x2'4m	8	Ø50mm	208cm	250cm	76cm	250cm	23x23x250cm
	2'5x2'5m	8	Ø50mm	218cm	275cm	90cm	275cm	23x23x275cm
	3x3m	8	Ø50mm	222cm	275cm	58cm	275cm	23x23x275cm

	2x2'5m	8	Ø50mm	194cm	250cm	81cm	250cm	23x23x250cm
	2x3m	8	Ø50mm	195cm	250cm	64cm	250cm	23x23x250cm
	2,5x3m	8	Ø50mm	206cm	275cm	69cm	275cm	23x23x275cm



# SERIE ESTANDAR EXTRA

**Parasol de aluminio**  
Aluminium parasol  
Parasol en aluminium

## ES

Parasol pequeño pero con la resistencia de los modelos de gama superior. Este parasol, una vez cerrado, tiene unas dimensiones reducidas que permiten almacenarlo en espacios pequeños. Gracias a su robustez y las opciones de PVC y cerramientos se convierte en un parasol ideal para zonas con un clima irregular.

## EN

Small parasol with the same resistance as the larger model. When closed, this parasol's compact dimensions make it storable in small spaces. This product is ideal for areas with unstable climate thanks to its robustness. Side-screens and PVC options available.

## FR

Petit parasol avec la résistance des grands modèles. Ce parasol, une fois fermé, a des dimensions qui permettent le ranger dans de petits espaces. Grâce à sa robustesse il devient un parasol idéal pour les zones à climat irrégulier. Options de PVC et bâches latérales disponibles.

Mástil **NO telescópico** Apertura **POLEAS**  
Pole **NOT telescopic** Opening **PULLEYS**  
Mât **NON télescopique** Ouverture **POULIES**

## Opciones / Options / Options

Acabados  
Finishes  
Finitions

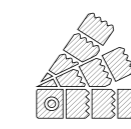

ref. TOP/TAS/TPS  
p. 84-87

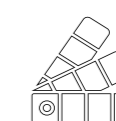

p.80

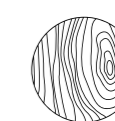

p.81



p.82

Accesorios  
Accessories  
Accessoires

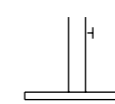

p.64-69

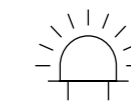

p.70-73



p.72



p.74

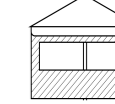

p.76

## Características / Features / Caractéristiques

SERIE  
ESTANDAR EXTRA

Mástil de aluminio lacado blanco.  
Colante y corona de aluminio.

White coated aluminium pole.  
Aluminium runner and notch.

Mât Aluminium laqué blanc.  
Coulant et noix en aluminium.



Mástil de Ø50mm (3mm de espesor).  
Sistema apertura mediante dos juegos  
de poleas dobles.

Ø50mm pole (3mm thickness).  
Opening system by two pulleys.

Mât Ø50mm (3mm d'épaisseur).  
Système d'ouverture par deux poulies.



Varillas perfil 20x30mm.  
Sujeción individual mediante tornillos.

Section 20x30mm ribs.  
Attached individually by screws.

Profile 20x30mm.  
Fixation individuelle par vis.

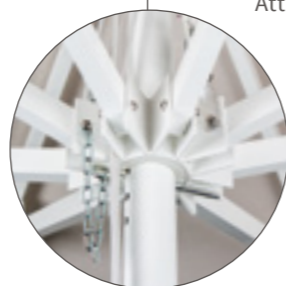

## Bases recomendadas / Suggested bases / Bases recommandées



Fijar 20  
Fijar 20  
Fixer 20



Metalica 65  
Metallic 65  
Metallique 65



Bases para empotrar  
Built in bases  
Bases à encaster



Resinada rellenable  
Refill resined  
Résine Rechargeable

TODAS LAS  
BASES /

ALL BASES /

TOUTES  
BASES

— p.64

## Tabla de medidas / Available sizes / Tableau de mesures

SERIE  
ESTANDAR EXTRA

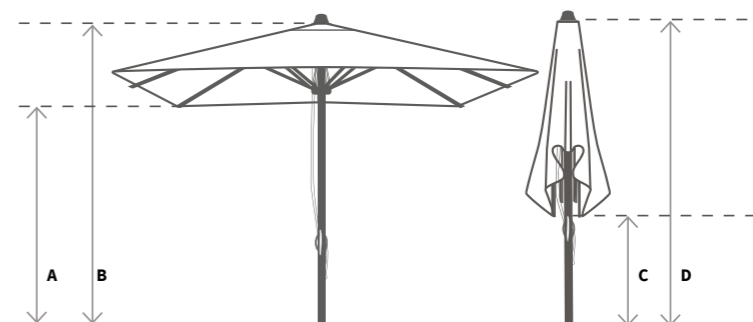

**A-** Altura varilla abierto  
Rib height open  
Hauteur baleine ouvert

**B-** Altura parasol abierto  
Open parasol height  
Hauteur parasol ouvert

**C-** Altura varilla cerrado  
Rib height closed  
Hauteur baleine fermé

**D-** Altura parasol cerrado  
Closed parasol height  
Hauteur parasol fermé

forma shape forme	medida measurement dimension	varillas ribs baleines	mástil pole mât	altura A height A hauteur A	altura B height B hauteur B	altura C height C hauteur C	altura D height D hauteur D	embalaje packaging emballage
	3m	8	Ø50mm	225cm	287cm	130cm	287cm	40x40x290cm
	3,5m	8	Ø50mm	225cm	297cm	113cm	297cm	40x40x300cm
	4m	8	Ø50mm	225cm	280cm	79cm	280cm	40x40x283cm
	2x2m	8	Ø50mm	225cm	271cm	128cm	271cm	40x40x274cm
	2'5x2'5m	8	Ø50mm	225cm	294cm	112cm	294cm	40x40x297cm
	3x3m	8	Ø50mm	225cm	285cm	69cm	285cm	40x40x288cm
	3'5x3'5m	8	Ø50mm	225cm	294cm	43cm	294cm	40x40x297cm
	2x2'5m	8	Ø50mm	194cm	250cm	81cm	250cm	23x23x250cm
	2x3m	8	Ø50mm	195cm	250cm	64cm	250cm	23x23x250cm
	2,5x3m	8	Ø50mm	206cm	275cm	69cm	275cm	23x23x275cm
	2,5x3m	8	Ø50mm	225cm	277cm	81cm	277cm	40x40x280cm
	2'5x3'5m	8	Ø50mm	225cm	283cm	67cm	283cm	40x40x286cm
	3x3'5m	8	Ø50mm	225cm	276cm	46cm	276cm	40x40x279cm



# SERIE ELITE

## Parasol de aluminio Aluminium parasol Parasol en aluminium

### ES

Parasol más económico dentro de la gama de mástiles de 70mm. Gracias a su amplio abanico de medidas se pueden crear tanto pequeñas como grandes instalaciones. A diferencia de los modelos telescópicos, la apertura mediante poleas permite su uso y almacenaje en espacios de altura reducida. Es un parasol destinado a la hostelería.

### EN

More affordable parasol among the 70mm pole range. Thanks to its wide array of sizes, both small and large installations can be created. Unlike the telescopic ones, its pulley opening makes it usable and storable in spaces with low headroom. It is a parasol designed for the hotel and catering industry.

### FR

Un parasol plus économique dans la gamme des mâts de 70mm. Grâce à sa large palette de dimensions, il est possible de réaliser des installations de petite et de grande taille. Contrairement aux télescopiques, son ouverture par poulies permet son utilisation et stockage dans des espaces de hauteur réduite. C'est un parasol destiné à l'hôtellerie et à la restauration.

Mástil **NO telescópico** Apertura **POLEAS**  
Pole **NOT telescopic** Opening **PULLEYS**  
Mât **NON télescopique** Ouverture **POULIES**

## Opciones / Options / Options

Acabados  
Finishes  
Finitions

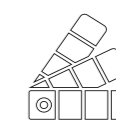
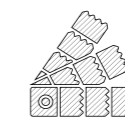

ref. **TOP/TAS/TPS**  
p. 84-87

p.80

p.81

p.82

Accesorios  
Accessories  
Accessoires

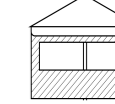
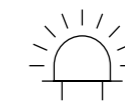
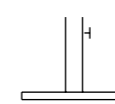

p.64-69

p.70-73

p.72

p.74

p.76



## Características / Features / Caractéristiques

SERIE  
ELITE

Mástil de aluminio lacado blanco.  
Colante y corona de aluminio.

White coated aluminium pole.  
Aluminium runner and notch.

Mât en aluminium laqué blanc.  
Coulant et noix en aluminium.



Mástil de  $\varnothing 70$ mm  
Sistema apertura mediante dos juegos  
de poleas dobles.

$\varnothing 70$ mm pole  
Opening system by two pulleys.

Mât  $\varnothing 70$ mm  
Système d'ouverture par deux poulies.



Varillas perfil 20x40mm.  
Sujeción individual mediante tornillos.

Section 20x40mm ribs.  
Attached individually by screws.

Profile 20x40mm.  
Fixation individuelle par vis.



## Bases recomendadas / Suggested bases / Bases recommandées



Fijar 20  
Fix 20  
Fixar 20



Metalica 65  
Metallic 65  
Metallique 65



Base de baldosas  
Tiles base  
Base delles



Bases para empotrar  
Built in bases  
Bases à encastrer

TODAS LAS  
BASES /  
ALL BASES /  
TOUTES  
BASES

— p.64

## Tabla de medidas / Available sizes / Tableau de mesures

SERIE  
ELITE

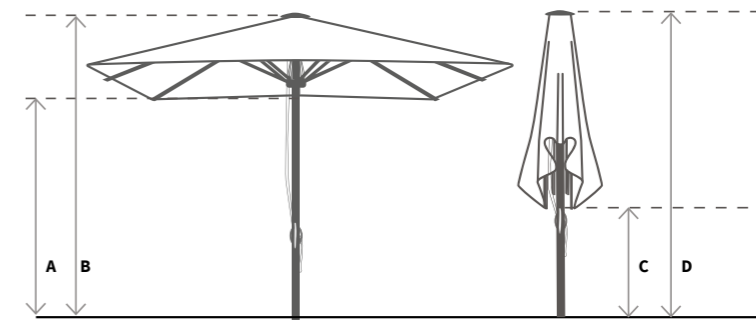

**A-** Altura varilla abierto  
Rib height open  
Hauteur baleine ouvert

**B-** Altura parasol abierto  
Open parasol height  
Hauteur parasol ouvert

**C-** Altura varilla cerrado  
Rib height closed  
Hauteur baleine fermé

**D-** Altura parasol cerrado  
Closed parasol height  
Hauteur parasol fermé

forma shape forme	medida measurement dimension	varillas ribs baleines	mástil pole mât	altura A height A hauteur A	altura B height B hauteur B	altura C height C hauteur C	altura D height D hauteur D	embalaje packaging emballage
	3m	8	Ø70mm	225cm	287cm	130cm	287cm	40x40x290cm
	3,5m	8	Ø70mm	225cm	297cm	113cm	297cm	40x40x300cm
	4m	8	Ø70mm	225cm	280cm	79cm	280cm	40x40x283cm
	2X2m	8	Ø70mm	225cm	271cm	128cm	271cm	40x40x274cm
	2'5x2'5m	8	Ø70mm	225cm	294cm	112cm	294cm	40x40x297cm
	3x3m	8	Ø70mm	225cm	285cm	69cm	285cm	40x40x288cm
	3'5x3'5m	8	Ø70mm	225cm	294cm	43cm	294cm	40x40x297cm
	4x4m	8	Ø70mm	225cm	309cm	20cm	309cm	40x40x312cm
	2x2'5m	8	Ø70mm	225cm	273cm	114cm	273cm	40x40x276cm
	2x3m	8	Ø70mm	225cm	268cm	91cm	268cm	40x40x271cm
	2x3,5m	8	Ø70mm	225cm	261cm	63cm	261cm	40x40x264cm
	2,5x3m	8	Ø70mm	225cm	277cm	81cm	277cm	40x40x280cm
	2'5x3'5m	8	Ø70mm	225cm	283cm	67cm	283cm	40x40x286cm
	3x3'5m	8	Ø70mm	225cm	276cm	46cm	276cm	40x40x279cm
	3x4m	8	Ø70mm	225cm	294cm	41cm	294cm	40x40x297cm
	3,5x4m	8	Ø70mm	225cm	322cm	47cm	322cm	40x40x325cm



# SERIE ELITE TELESCÓPICO

Parasol de aluminio  
Aluminium parasol  
Parasol en aluminium

## ES

Parasol fuerte y resistente. Destaca por un sistema de apertura telescópica con varilla que permite cerrar el parasol sin necesidad de apartar mesas, sillas o el mobiliario situado debajo. Es un parasol destinado a la hostelería.

## EN

Strong and resistant parasol. It stands due to its telescopic opening system with a tick allowing the parasol to be closed without removing the furniture underneath. It is a model designed for the hotel and catering industry.

## FR

Parasol solide et résistant. Il se distingue par son système d'ouverture télescopique avec une tige qui permet de fermer le parasol sans enlever les meubles en dessous. C'est un parasol destiné à l'hôtellerie et à la restauration.

Mástil **TELESCÓPICO** Apertura **SEMI-AUTO con varilla manual**

Pole **TELESCOPIC** Opening **SEMI-AUTO push and pull**

Mât **TÉLESCOPIQUE** Ouverture **SEMI-AUTO avec tige manuelle**

## Opciones / Options / Options

Acabados  
Finishes  
Finitions

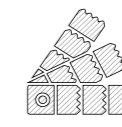

ref. **TAS/TPS**  
p. 84-87

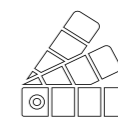

p.80



p.81



p.82

Accesorios  
Accessories  
Accessoires

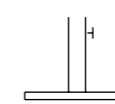

p.64-69

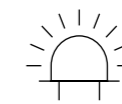

p.70-73



p.72



p.74

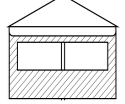

p.76

## Características / Features / Caractéristiques

SERIE  
ELITE TELESCÓPICO

Colante y corona de aluminio y/o polietileno con soporte inox para las varillas.

Aluminium and/or polyethylene runner and notch with inox brackets for ribs.

Coulant et noix en aluminium et/ou polyéthylène avec support de baleine en inox.



\*Para abrir el parasol se coloca un extremo de la varilla en la corona y se tira hacia abajo y para cerrar se tira hacia arriba. La varilla puede ponerse y quitarse cuando convenga.

\*To open the parasol, place one end of the tick in the crown and pull it down, and to close it, pull it up. The tick can be put on and taken off as required.

\*Pour ouvrir le parasol, placez une extrémité de la tige dans la couronne et tirez-la vers le bas, et pour la fermer, tirez-la vers le haut. La tige peut être mise et enlevée à volonté.

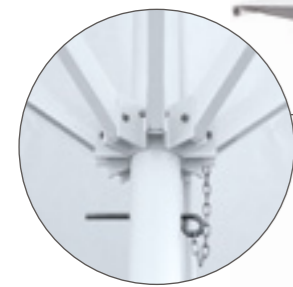

Mástil de  $\varnothing 70$ mm.  
Sistema apertura telescópico mediante varilla manual\*.

$\varnothing 70$ mm pole.  
Telescopic opening system with manual tick\*.

Mât  $\varnothing 70$ mm.  
Système d'ouverture télescopique avec tige manuelle\*.



Varillas perfil 20x40mm.  
Sujeción individual mediante tornillos.

Section 20x40mm ribs.  
Attached individually by screws.

Profile 20x40mm.  
Fixation individuelle par vis.

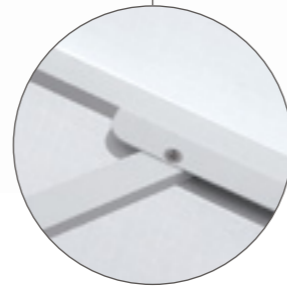

## Bases recomendadas / Suggested bases / Bases recommandées



Fijar 20  
Fix 20  
Fixar 20



Metalica 65  
Metallic 65  
Metalique 65



Base jardinera  
Planter base  
Base jardinière



Tapa abatible  
Base with lid  
Couvercle rabattable

TODAS LAS BASES /  
ALL BASES /  
TOUTES BASES

— p.64

## Tabla de medidas / Available sizes / Tableau de mesures

SERIE  
ELITE TELESCÓPICO

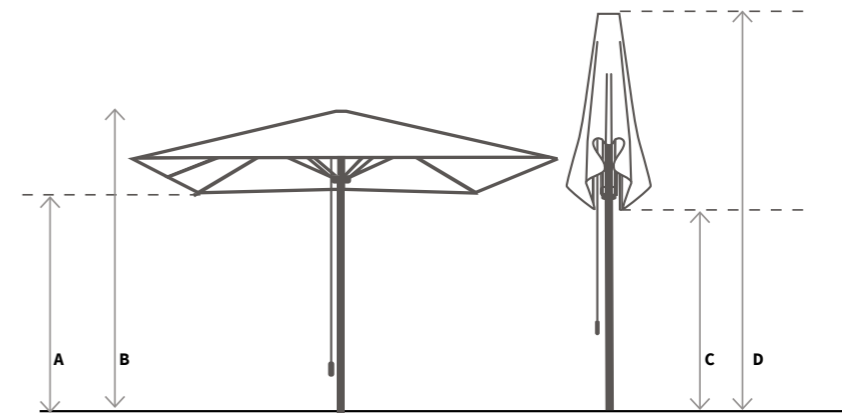

**A-** Altura varilla abierto  
Rib height open  
Hauteur baleine ouvert

**B-** Altura parasol abierto  
Open parasol height  
Hauteur parasol ouvert

**C-** Altura varilla cerrado  
Rib height closed  
Hauteur baleine fermé

**D-** Altura parasol cerrado  
Closed parasol height  
Hauteur parasol fermé

forma shape forme	medida measurement dimension	varillas ribs baleines	mástil pole mât	altura A height A hauteur A	altura B height B hauteur B	altura C height C hauteur C	altura D height D hauteur D	embalaje packaging emballage
	3m	8	$\varnothing 70$ mm	225cm	287cm	182cm	340cm	40x40x343cm
	3'5m	8	$\varnothing 70$ mm	225cm	297cm	166cm	350cm	40x40x353cm
	4m	8	$\varnothing 70$ mm	225cm	281cm	168cm	370cm	40x40x373cm
	5m	8	$\varnothing 70$ mm	225cm	316cm	166cm	426cm	40x40x429cm
	2x2m	8	$\varnothing 70$ mm	225cm	271cm	204cm	347cm	40x40x350cm
	2'5x2'5m	8	$\varnothing 70$ mm	225cm	285cm	185cm	367cm	40x40x370cm
	3x3m	8	$\varnothing 70$ mm	225cm	287cm	152cm	368cm	40x40x371cm
	3'5x3'5m	8	$\varnothing 70$ mm	225cm	294cm	144cm	395cm	40x40x398cm
	4x4m	8	$\varnothing 70$ mm	225cm	311cm	112cm	400cm	40x40x403cm
	4,5x4,5m	8	$\varnothing 70$ mm	225cm	310cm	98cm	423cm	40x40x426cm
	2x2'5m	8	$\varnothing 70$ mm	225cm	273cm	209cm	369cm	40x40x372cm
	2x3m	8	$\varnothing 70$ mm	225cm	270cm	193cm	372cm	40x40x375cm
	2x3'5m	8	$\varnothing 70$ mm	225cm	263cm	167cm	365cm	40x40x368cm
	2x4m	8	$\varnothing 70$ mm	225cm	275cm	140cm	363cm	40x40x366cm
	2'5x3m	8	$\varnothing 70$ mm	225cm	277cm	151cm	346cm	40x40x349cm
	2'5x3'5m	8	$\varnothing 70$ mm	225cm	283cm	185cm	400cm	40x40x403cm
	2'5x4m	8	$\varnothing 70$ mm	225cm	273cm	154cm	388cm	40x40x491cm
	2'5x4'5m	8	$\varnothing 70$ mm	225cm	289cm	104cm	362cm	40x40x365cm
	3x3'5m	8	$\varnothing 70$ mm	225cm	276cm	167cm	395cm	40x40x398cm
	3x4m	8	$\varnothing 70$ mm	225cm	295cm	142cm	395cm	40x40x398cm
	3x4'5m	8	$\varnothing 70$ mm	225cm	292cm	100cm	372cm	40x40x375cm
	3'5x4m	8	$\varnothing 70$ mm	225cm	322cm	177cm	440cm	40x40x443cm
	3'5x4'5m	8	$\varnothing 70$ mm	225cm	305cm	75cm	363cm	40x40x366cm
	4x4,5m	8	$\varnothing 70$ mm	225cm	319cm	105cm	414cm	40x40x417cm



# SERIE ELITE PLUS

**Parasol de aluminio**  
Aluminium parasol  
Parasol en aluminium

**ES**

Parasol de gran resistencia y dimensiones. Es el único de la gama Elite con apertura telescópica mediante manivela con husillo

**EN**

Parasol offering great resistance and size. This parasol is the only one in the Elite range with a crank telescopic opening.

**FR**

Parasol de grande résistance et dimensions. C'est le seul parasol de la gamme Elite à avoir une ouverture télescopique par manivelle avec vis sans fin.

Mástil **TELESCÓPICO** Apertura **MANIVELA con husillo**  
Pole **TELESCOPIC** Opening **CRANK with endless screw**  
Mât **TÉLESCOPIQUE** Ouverture **MANIVELLE avec vis sans fin**

## Opciones / Options / Options

Acabados  
Finishes  
Finitions

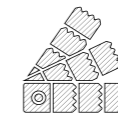

ref. **TAS/TPS**  
p. 84-87

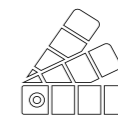

p.80

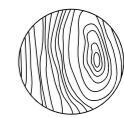

p.81



p.82

Accesorios  
Accessories  
Accessoires



p.64-69



p.70-73



p.72



p.74

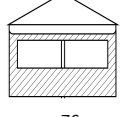

p.76

## Características / Features / Caractéristiques

SERIE  
ELITE PLUS

Colante y corona de aluminio y/o polietileno con soporte inox para las varillas.

Aluminium and/or polyethylene runner and notch with inox brackets for ribs.

Coulant et noix en aluminium et/ou polyéthylène avec support de baleine en inox.



Mástil de  $\varnothing 70$ mm. Sistema apertura telescópica con mecanismo de manivela.

$\varnothing 70$ mm pole. Telescopic opening system with manual crank.

Mât  $\varnothing 70$ mm. Système d'ouverture télescopique avec manivelle manuelle.



Varillas perfil 20x40mm. Sujeción individual mediante tornillos.

Section 20x40mm ribs. Attached individually by screws.

Profile 20x40mm. Fixation individuelle par vis.



## Bases recomendadas / Suggested bases / Bases recommandées



Fijar 20  
Fix 20  
Fixar 20



Metalica 65  
Metallic 65  
Metalique 65



Base jardinera  
Planter base  
Base jardinière



Tapa abatible  
Base with lid  
Couvercle rabattable

TODAS LAS BASES /

ALL BASES /

TOUTES BASES

— p.64

## Tabla de medidas / Available sizes / Tableau de mesures

SERIE  
ELITE PLUS

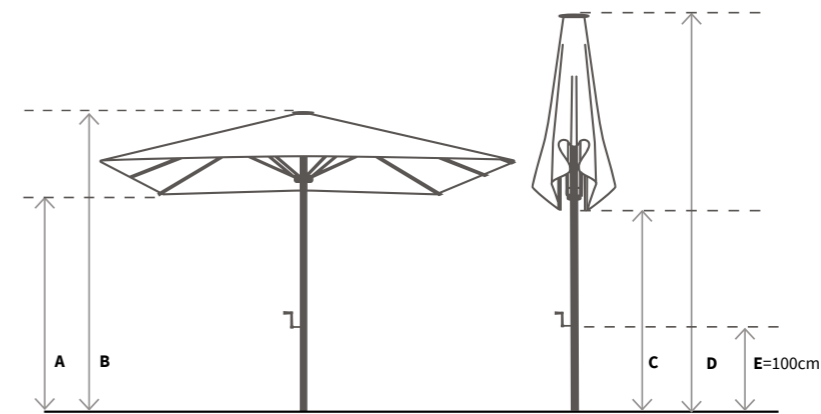

**A** - Altura varilla abierto  
Rib height open  
Hauteur baleine ouvert

**B** - Altura parasol abierto  
Open parasol height  
Hauteur parasol ouvert

**C** - Altura varilla cerrado  
Rib height closed  
Hauteur baleine fermé

**D** - Altura parasol cerrado  
Closed parasol height  
Hauteur parasol fermé

**E** - Altura manivela  
Crank height  
Hauteur manivelle

forma shape forme	medida measurement dimension	varillas ribs baleines	mástil pole mât	altura A height A hauteur A	altura B height B hauteur B	altura C height C hauteur C	altura D height D hauteur D	embalaje packaging emballage
	3m	8	$\varnothing 70$ mm	225cm	287cm	207cm	365cm	40x40x368cm
	3'5m	8	$\varnothing 70$ mm	225cm	297cm	166cm	350cm	40x40x353cm
	4m	8	$\varnothing 70$ mm	225cm	281cm	168cm	370cm	40x40x373cm
	5m	8	$\varnothing 70$ mm	225cm	316cm	140cm	404cm	40x40x407cm
	2x2m	8	$\varnothing 70$ mm	225cm	271cm	207cm	348cm	40x40x351cm
	2'5x2'5m	8	$\varnothing 70$ mm	225cm	285cm	192cm	373cm	40x40x376cm
	3x3m	8	$\varnothing 70$ mm	225cm	287cm	151cm	365cm	40x40x368cm
	3'5x3'5m	8	$\varnothing 70$ mm	225cm	294cm	154cm	403cm	40x40x406cm
	4x4m	8	$\varnothing 70$ mm	225cm	311cm	110cm	400cm	40x40x403cm
	4,5x4,5m	8	$\varnothing 70$ mm	225cm	310cm	82cm	409cm	40x40x412cm
	2x2'5m	8	$\varnothing 70$ mm	225cm	273cm	209cm	369cm	40x40x372cm
	2x3m	8	$\varnothing 70$ mm	225cm	270cm	174cm	358cm	40x40x361cm
	2x3'5m	8	$\varnothing 70$ mm	225cm	263cm	167cm	365cm	40x40x368cm
	2x4m	8	$\varnothing 70$ mm	225cm	275cm	140cm	363cm	40x40x366cm
	2'5x3m	8	$\varnothing 70$ mm	225cm	277cm	151cm	346cm	40x40x349cm
	2'5x3'5m	8	$\varnothing 70$ mm	225cm	283cm	174cm	390cm	40x40x393cm
	2'5x4m	8	$\varnothing 70$ mm	225cm	273cm	154cm	388cm	40x40x491cm
	2'5x4'5m	8	$\varnothing 70$ mm	225cm	289cm	142cm	403cm	40x40x406cm
	3x3'5m	8	$\varnothing 70$ mm	225cm	276cm	167cm	395cm	40x40x398cm
	3x4m	8	$\varnothing 70$ mm	225cm	295cm	142cm	395cm	40x40x398cm
	3x4'5m	8	$\varnothing 70$ mm	225cm	292cm	100cm	372cm	40x40x375cm
	3'5x4m	8	$\varnothing 70$ mm	225cm	322cm	177cm	440cm	40x40x443cm
	3'5x4'5m	8	$\varnothing 70$ mm	225cm	305cm	75cm	363cm	40x40x366cm
	4x4,5m	8	$\varnothing 70$ mm	225cm	319cm	105cm	414cm	40x40x417cm



# SERIE ELITE DESPLAZADO

**Parasol de aluminio**  
Aluminium parasol  
Parasol en aluminium

**ES**

Parasol de la colección Elite con la particularidad que tiene el mástil desplazado del eje central, situado a 50cm del lateral y apertura telescópica. Ideal para terrazas con un espacio estrecho. Junto con los complementos de cerramientos laterales y canaletas permite crear espacios íntimos sin la molestia de un mástil en medio.

**EN**

Parasol from the Elite collection with a special feature: its pole is shifted from the central axis and located 50cm from the side and telescopic opening. It is ideal for narrow terraces. By adding side screens and gutters it allows for intimate spaces without the inconvenience of a central pole.

**FR**





Parasol de la collection Elite avec la particularité d'avoir le mât déplacé par rapport à l'axe central, situé à 50cm du côté et ouverture télescopique.. Idéal pour des terrasses étroites. Avec des bâches latérales et des gouttières, il permet de créer des espaces intimes sans les inconvénients d'un mât central.

Mástil **TELESCÓPICO** Apertura **SEMI-AUTO con varilla manual**

Pole **TELESCOPIC** Opening **SEMI-AUTO push and pull**

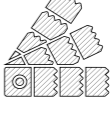
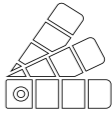
Mât **TÉLESCOPIQUE** Ouverture **SEMI-AUTO avec tige manuelle**

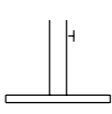
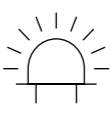
## Opciones / Options / Options

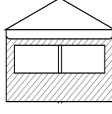
Acabados Finishes Finitions		 ref. <b>TAS/TPS</b> p. 84-87	 p.80	 p.81	 p.82
Accesorios Accessories Accessoires	 p.64-69	 p.70-73	 p.72	 p.74	 p.76

## Características / Features / Caractéristiques

SERIE  
ELITE DESPLAZADO

Colante y corona de aluminio y/o polietileno con soporte inox para las varillas.

Aluminium and/or polyethylene runner and notch with inox brackets for ribs.

Coulant et noix en aluminium et/ou polyéthylène avec support de baleine en inox.

\*Para abrir el parasol se coloca un extremo de la varilla en la corona y se tira hacia abajo y para cerrar se tira hacia arriba. La varilla puede ponerse y quitarse cuando convenga.

\*To open the parasol, place one end of the tick in the crown and pull it down, and to close it, pull it up. The tick can be put on and taken off as required.

\*Pour ouvrir le parasol, placez une extrémité de la tige dans la couronne et tirez-la vers le bas, et pour la fermer, tirez-la vers le haut. La tige peut être mise et enlevée à volonté.



Varillas perfil 20x40mm.  
Sujeción individual mediante tornillos.

Section ribs 20x40mm.  
Attached individually by screws.

Baleines profile 20x40mm.  
Fixation individuelle par vis.

Mástil de  $\varnothing 70$ mm. Sistema apertura telescópico con varilla manual\*.

$\varnothing 70$ mm pole. Telescopic opening system with manual tick\*.

Mât  $\varnothing 70$ mm. Système d'ouverture télescopique avec tige manuelle\*.



## Bases recomendadas / Suggested bases / Bases recommandées



TODAS LAS BASES /  
ALL BASES /  
TOUTES BASES

— p.64

## Tabla de medidas / Available sizes / Tableau de mesures

SERIE  
ELITE DESPLAZADO

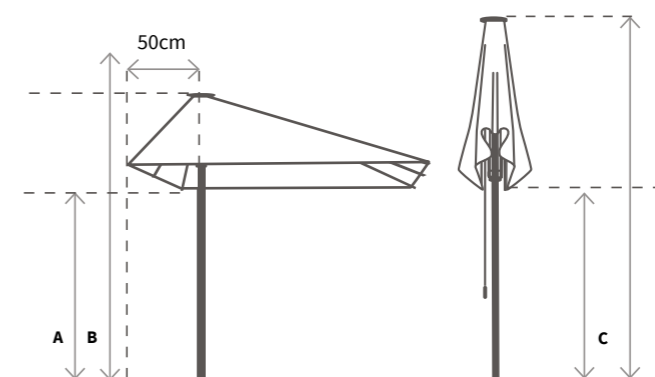

**A-** Altura varilla abierto  
Rib height open  
Hauteur baleine ouvert

**B-** Altura parasol abierto  
Open parasol height  
Hauteur parasol ouvert

**C-** Altura varilla cerrado  
Rib height closed  
Hauteur baleine fermé

**D-** Altura parasol cerrado  
Closed parasol height  
Hauteur parasol fermé

forma shape forme	medida measurement dimension	varillas ribs baleines	mástil pole mât	altura A height A hauteur A	altura B height B hauteur B	altura C height C hauteur C	altura D height D hauteur D	embalaje packaging emballage
	2x2m	6	$\varnothing 70$ mm	225cm	271cm	186cm	365cm	40x40x368cm
	2'5x2'5m	6	$\varnothing 70$ mm	225cm	285cm	185cm	367cm	40x40x368cm
	1,5x2m	6	$\varnothing 70$ mm	225cm	273cm	215cm	357cm	40x40x360cm
	1,5x2,5m	6	$\varnothing 70$ mm	225cm	280cm	165cm	365cm	40x40x368cm
	1,5x3m	6	$\varnothing 70$ mm	225cm	285cm	185cm	368cm	40x40x371cm
	1,5x3,5m	6	$\varnothing 70$ mm	225cm	293cm	162cm	369cm	40x40x372cm
	2x2'5m	6	$\varnothing 70$ mm	225cm	271cm	171cm	365cm	40x40x368cm
	2x3m	6	$\varnothing 70$ mm	225cm	271cm	129cm	381cm	40x40x384cm
	2x3'5m	6	$\varnothing 70$ mm	225cm	282cm	146cm	377cm	40x40x380cm
	2x4m	6	$\varnothing 70$ mm	225cm	277cm	132cm	380cm	40x40x383cm
	2x4'5m	6	$\varnothing 70$ mm	225cm	283cm	123cm	393cm	40x40x396cm
	2'5x2m	6	$\varnothing 70$ mm	225cm	280cm	147cm	375cm	40x40x378cm
	2'5x3m	6	$\varnothing 70$ mm	225cm	279cm	152cm	400cm	40x40x403cm
	2'5x3'5m	6	$\varnothing 70$ mm	225cm	287cm	144cm	410cm	40x40x413cm
	2'5x4m	6	$\varnothing 70$ mm	225cm	294cm	134cm	419cm	40x40x421cm
2'5x4'5m	6	$\varnothing 70$ mm	225cm	302cm	106cm	410cm	40x40x413cm	



# SERIE PALMA

**Parasol de aluminio**  
Aluminium parasol  
Parasol en aluminium

## ES

Parasol que se fabrica en diversas medidas y de grandes dimensiones, gracias a su estructura con un resistente mástil de 90mm de diámetro. Es un parasol fuerte y robusto ideal para medianas y grandes instalaciones.

## EN

Parasol allowing for the largest dimensions and most varied sizes in our collection thanks to its sturdy 90mm diameter pole. Its crank makes it easier to open up. It is a strong and robust parasol that is for medium to large installations.

## FR

Parasol qui permet les plus grandes dimensions et les mesures les plus diverses dans notre collection grâce à son mât résistant de 90mm de diamètre. Sa manivelle permet de l'ouvrir facilement. C'est un parasol solide et robuste, idéal pour des installations de taille moyenne à grande.

Mástil **TELESCÓPICO** Apertura **MANIVELA con husillo**  
Pole **TELESCOPIC** Opening **CRANK with endless screw**  
Mât **TÉLESCOPIQUE** Ouverture **MANIVELLE avec vis sans fin**

## Opciones / Options / Options

Acabados  
Finishes  
Finitions

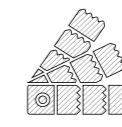

ref. **TAS/TPS**  
p. 84-87



p.80

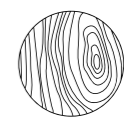

p.81



p.82

Accesorios  
Accessories  
Accessoires

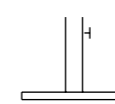

p.64-69

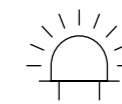

p.70-73



p.72



p.74

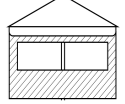

p.76



## Características / Features / Caractéristiques

SERIE  
PALMA

Colante y corona de aluminio y/o polietileno con soporte inox para las varillas.

Aluminium and/or polyethylene runner and notch with inox brackets for ribs.

Coulant et noix en aluminium et/ou polyéthylène avec support de baleine en inox.



Varillas perfil 20x40mm.  
Sujeción individual mediante tornillos.

Section 20x40mm ribs.  
Attached individually by screws.

Profile 20x40mm.  
Fixation individuelle par vis.

Mástil de ø90cm. Estructura de aluminio lacado blanco. Sistema telescópico con manivela.

90cm pole. White coated aluminium frame. Telescopic opening system with crank.

Mât de ø90mm. Monture en aluminium laqué blanc. Système télescopique avec manivelle.



## Bases recomendadas / Suggested bases / Bases recommandées



Fijar 20  
Fix 20  
Fixar 20



Base de baldosas  
Tiles base  
Base delles



Base jardinera  
Planter base  
Base jardinière



Bases para empotrar  
Built in bases  
Bases à encastrer

TODAS LAS BASES /

ALL BASES /

TOUTES BASES

— p.64

## Tabla de medidas / Available sizes / Tableau de mesures

SERIE  
PALMA

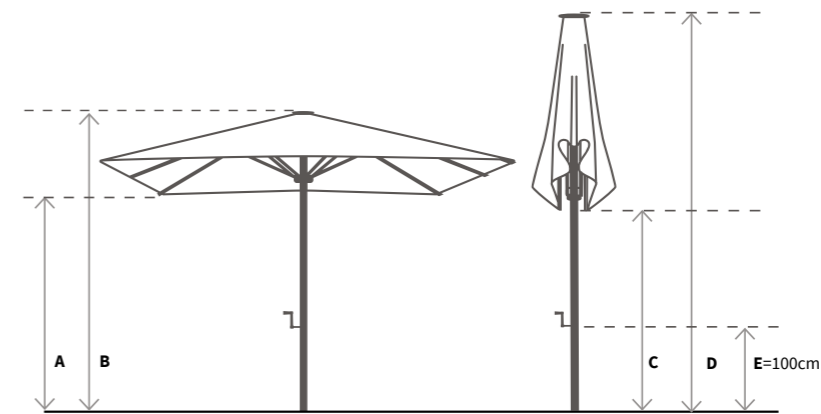

**A**- Altura varilla abierto  
Rib height open  
Hauteur baleine ouvert

**B**- Altura parasol abierto  
Open parasol height  
Hauteur parasol ouvert

**C**- Altura varilla cerrado  
Rib height closed  
Hauteur baleine fermé

**D**- Altura parasol cerrado  
Closed parasol height  
Hauteur parasol fermé

**E**- Altura manivela  
Crank height  
Hauteur manivelle

forma shape forme	medida measurement dimension	varillas ribs baleines	mástil pole mât	altura A height A hauteur A	altura B height B hauteur B	altura C height C hauteur C	altura D height D hauteur D	embalaje packaging emballage
	4m	8	ø90mm	225cm	282cm	162cm	364cm	40x40x367cm
	5m	8	ø90mm	225cm	314cm	160cm	421cm	40x40x424cm
	2'5x2'5m	8	ø90mm	225cm	276cm	169cm	349cm	40x40x352cm
	3x3m	8	ø90mm	225cm	293cm	138cm	356cm	40x40x359cm
	3'5x3'5m	8	ø90mm	225cm	291cm	137cm	387cm	40x40x390cm
	4x4m	8	ø90mm	225cm	296cm	99cm	386cm	40x40x389cm
	4'5x4'5m	8	ø90mm	225cm	309cm	76cm	396cm	40x40x399cm
	5x5m	8	ø90mm	225cm	319cm	*53cm	412cm	40x40x415cm
	5'5x5'5m	8	ø90mm	225cm	329cm	*42cm	435cm	40x40x438cm
	2x2'5m	8	ø90mm	225cm	265cm	169cm	329cm	40x40x332cm
	2x3m	8	ø90mm	225cm	273cm	154cm	334cm	40x40x337cm
	2x3'5m	8	ø90mm	225cm	284cm	153cm	357cm	40x40x360cm
	2x4m	8	ø90mm	225cm	279cm	135cm	359cm	40x40x362cm
	2'5x3m	8	ø90mm	225cm	263cm	146cm	338cm	40x40x341cm
	2'5x3'5m	8	ø90mm	225cm	278cm	140cm	354cm	40x40x357cm
	2'5x4m	8	ø90mm	225cm	282cm	132cm	368cm	40x40x371cm
	2'5x4'5m	8	ø90mm	225cm	287cm	105cm	362cm	40x40x365cm
	2'5x5m	8	ø90mm	225cm	293cm	105cm	386cm	40x40x389cm
	2'5x5'5m	8	ø90mm	225cm	314cm	89cm	395cm	40x40x398cm
	3x3'5m	8	ø90mm	225cm	291cm	165cm	398cm	40x40x401cm
	3x4m	8	ø90mm	225cm	265cm	133cm	378cm	40x40x381cm
	3x4'5m	8	ø90mm	225cm	291cm	94cm	366cm	40x40x369cm
	3x5m	8	ø90mm	225cm	309cm	92cm	386cm	40x40x389cm
	3x5'5m	8	ø90mm	225cm	312cm	*62cm	396cm	40x40x399cm
	3'5x4m	8	ø90mm	225cm	315cm	159cm	433cm	40x40x436cm
	3'5x4'5m	8	ø90mm	225cm	300cm	88cm	375cm	40x40x378cm
	3'5x5m	8	ø90mm	225cm	316cm	80cm	390cm	40x40x393cm
	3'5x5'5m	8	ø90mm	225cm	317cm	79cm	410cm	40x40x413cm
4x4'5m	8	ø90mm	225cm	308cm	91cm	398cm	40x40x401cm	
4x5m	8	ø90mm	225cm	341cm	117cm	432cm	40x40x435cm	
4x5'5m	8	ø90mm	225cm	327cm	*52cm	399cm	40x40x402cm	
4'5x5m	8	ø90mm	225cm	319cm	79cm	420cm	40x40x423cm	
4'5x5'5m	8	ø90mm	225cm	328cm	*63cm	425cm	40x40x428cm	
5x5'5m	8	ø90mm	225cm	335cm	*61cm	443cm	40x40x445cm	

\*Hay que separar el mobiliario para cerrar el parasol. /\* You have to separate the furniture to close the parasol. /\* Il faut séparer les meubles pour fermer le parasol.



# SERIE PALMA DESPLAZADO

**Parasol de aluminio**  
Aluminium parasol  
Parasol en aluminium

## ES

Parasol con las mismas características del Palma, con la diferencia que el mástil está situado a 50cm del lateral. Al ser un parasol con un mástil de 90mm, nos permite fabricar mayores dimensiones que el modelo Elite de mástil desplazado. Permite crear grandes espacios cubiertos, sin la molestia de un mástil central. Ideal para aprovechar al máximo el espacio de tu terraza.

## EN







Everything in this parasol is the same as the Palma model but its pole is located 50cm from the side. As it is a parasol with a 90mm pole, it allows larger dimensions than the shifted Elite. This model enables us to create large covered spaces without the inconvenience of a central pole. It is ideal for making the most of your terrace space.

## FR

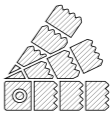
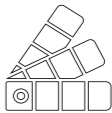
Parasol avec les mêmes caractéristiques que le Palma, avec la différence de son mât situé à 50cm du côté. Puisque c'est un parasol avec un mât de 90mm, il nous permet de fabriquer des dimensions plus grandes que l'Elite déplacé. Il facilite la création de grands espaces couverts, sans les inconvénients d'un mât central. Ce parasol est idéal pour profiter au maximum de votre espace terrasse.

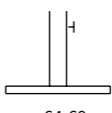
Mástil **TELESCÓPICO** Apertura **MANIVELA con husillo**  
Pole **TELESCOPIC** Opening **CRANK with endless screw**  
Mât **TÉLESCOPIQUE** Ouverture **MANIVELLE avec vis sans fin**

## Opciones / Options / Options

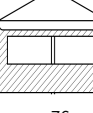
Acabados Finishes Finitions		 ref. <b>TAS/TPS</b> p. 84-87	 p.80	 p.81	 p.82
Accesorios Accessories Accessoires	 p.64-69	 p.70-73	 p.72	 p.74	 p.76

## Características / Features / Caractéristiques

SERIE  
PALMA DESPLAZADO

Colante y corona de aluminio y/o polietileno con soporte inox para las varillas.

Aluminium and/or polyethylene runner and notch with inox brackets for ribs.

Coulant et noix en aluminium et/ou polyéthylène avec support de baleine en inox.



Varilla de perfil 20x40mm.  
Sujeción individual mediante tornillos.

Section 20x40mm ribs.  
Attached individually by screws.

Profile 20x40mm.  
Fixation individuelle par vis.

Mástil de ø90cm. Estructura de aluminio lacado blanco. Sistema telescópico con manivela.

90cm pole. White coated aluminium frame. Telescopic opening system with crank.

Mât de ø90mm. Monture en aluminium laqué blanc. Système télescopique avec manivelle.



## Bases recomendadas / Suggested bases / Bases recommandées



Fijar 20  
Fix 20  
Fixar 20



Base de baldosas  
Tiles base  
Base delles



Base jardinera  
Planter base  
Base jardinière



Bases para empotrar  
Built in bases  
Bases à encaster

TODAS LAS BASES /

ALL BASES /

TOUTES BASES

— p.64

## Tabla de medidas / Available sizes / Tableau de mesures

SERIE  
PALMA DESPLAZADO

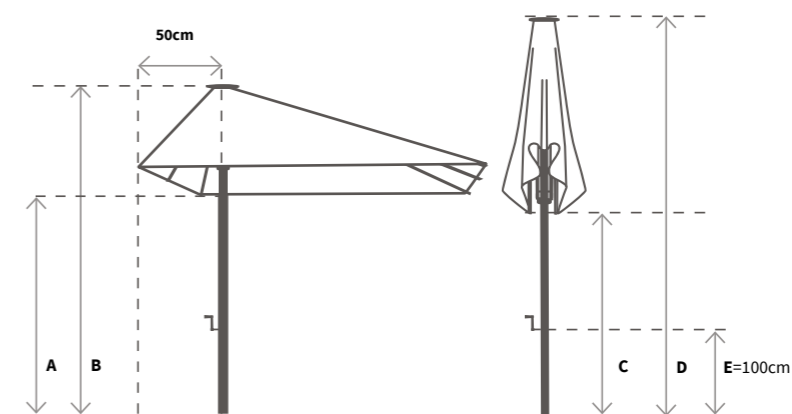

**A** - Altura varilla abierto  
Rib height open  
Hauteur baleine ouvert

**B** - Altura parasol abierto  
Open parasol height  
Hauteur parasol ouvert

**C** - Altura varilla cerrado  
Rib height closed  
Hauteur baleine fermé

**D** - Altura parasol cerrado  
Closed parasol height  
Hauteur parasol fermé

**E** - Altura manivela  
Crank height  
Hauteur manivelle

forma shape forme	medida measurement dimension	varillas ribs baleines	mástil pole mât	altura A height A hauteur A	altura B height B hauteur B	altura C height C hauteur C	altura D height D hauteur D	embalaje packaging emballage
-------------------------	------------------------------------	------------------------------	-----------------------	-----------------------------------	-----------------------------------	-----------------------------------	-----------------------------------	------------------------------------

	2,5x2,5m	6	ø90mm	225cm	285cm	185cm	367cm	40x40x368cm
	3x3m	6	ø90mm	225cm	306cm	106cm	402cm	40x40x406cm

	2x2'5m	6	ø90mm	225cm	271cm	171cm	365cm	40x40x368cm
	2x3m	6	ø90mm	225cm	271cm	129cm	381cm	40x40x384cm
	2x3'5m	6	ø90mm	225cm	282cm	146cm	377cm	40x40x380cm
	2x4m	6	ø90mm	225cm	277cm	132cm	380cm	40x40x383cm
	2x4'5m	6	ø90mm	225cm	283cm	123cm	393cm	40x40x396cm
	2'5x3m	6	ø90mm	225cm	279cm	152cm	400cm	40x40x403cm
	2'5x3'5m	6	ø90mm	225cm	287cm	144cm	410cm	40x40x413cm
	2'5x4m	6	ø90mm	225cm	294cm	134cm	419cm	40x40x421cm
	2'5x4'5m	6	ø90mm	225cm	302cm	106cm	410cm	40x40x413cm
	2,5x5m	6	ø90mm	225cm	313cm	92cm	417cm	40x40x420cm
	3x3,5m	6	ø90mm	225cm	310cm	104cm	413cm	40x40x416cm
	3x4m	6	ø90mm	225cm	314cm	93,2cm	417cm	40x40x420cm
	3x4,5m	6	ø90mm	225cm	318cm	95,6cm	437cm	40x40x440cm



# SERIE BERLIN

**Parasol de aluminio**  
Aluminium parasol  
Parasol en aluminium

**ES**

Parasol de distinguido diseño; el único de nuestra colección con mástil cuadrado. Es un parasol firme y sólido idóneo para grandes terrazas. Al ser tan resistente permite la fabricación de grandes medidas. El uso de una manivela facilita su apertura.

**EN**

Parasol with a fine design; the only one in our collection with a square pole. It is a strong parasol suitable for large terraces. Its resistance allows to manufacture it in large sizes. The use of a crank makes it easy to open.

**FR**

Parasol avec design distingué; le seul dans notre collection avec un mât carré. C'est un parasol ferme et solide idéal pour des grandes terrasses. Sa résistance permet la fabrication de grandes dimensions. L'utilisation d'une manivelle permet de l'ouvrir facilement.

Mástil **TELESCÓPICO** Apertura **MANIVELA con husillo**  
Pole **TELESCOPIC** Opening **CRANK with endless screw**  
Mât **TÉLESCOPIQUE** Ouverture **MANIVELLE avec vis sans fin**

## Opciones / Options / Options

Acabados  
Finishes  
Finitions

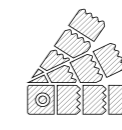

ref. **TAS/TPS**  
p. 84-87

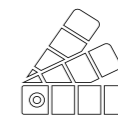

p.80



p.82

Accesorios  
Accessories  
Accessoires



p.64-69

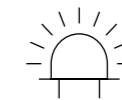

p.70-73



p.72



p.74

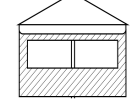

p.76

## Características / Features / Caractéristiques

SERIE  
BERLIN

Corona de aluminio y colante de polietileno con soporte inox para las varillas.

Aluminium notch and polyethylene runner with inox brackets for ribs.

Noix en aluminium et coulant en polyéthylène avec support de baleine en inox.

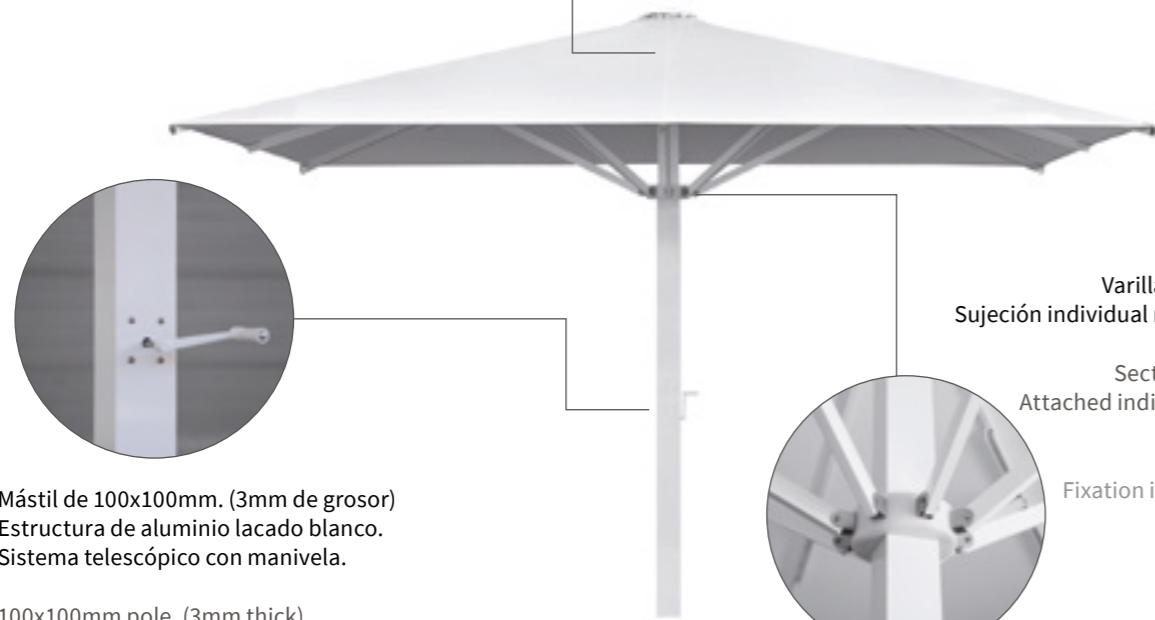

Varillas perfil 20x40mm.  
Sujeción individual mediante tornillos.

Section 20x40mm ribs.  
Attached individually by screws.

Profile 20x40mm.  
Fixation individuelle par vis.

Mástil de 100x100mm. (3mm de grosor)  
Estructura de aluminio lacado blanco.  
Sistema telescópico con manivela.

100x100mm pole. (3mm thick).  
White coated aluminium frame  
Telescopic opening system with crank.

Mât de 100x100mm. (3mm d'épaisseur)  
Monture en aluminium laqué blanc.  
Système télescopique avec manivelle.



## Bases recomendadas / Suggested bases / Bases recommandées



Fijar 20  
Fix 20  
Fixar 20



Base de baldosas  
Tiles base  
Base delles



Base jardinera  
Planter base  
Base jardinière



Bases para empotrar  
Built in bases  
Bases à encastrer

TODAS LAS BASES /

ALL BASES /

TOUTES BASES

— p.64

## Tabla de medidas / Available sizes / Tableau de mesures

SERIE  
BERLIN

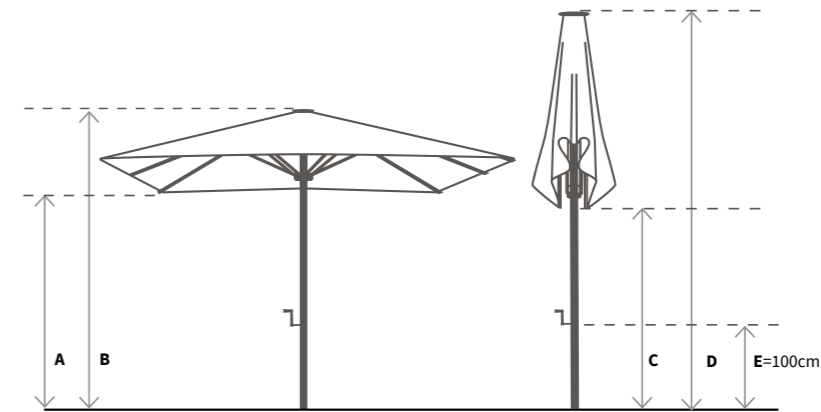

**A**- Altura varilla abierto  
Rib height open  
Hauteur baleine ouvert

**B**- Altura parasol abierto  
Open parasol height  
Hauteur parasol ouvert

**C**- Altura varilla cerrado  
Rib height closed  
Hauteur baleine fermé

**D**- Altura parasol cerrado  
Closed parasol height  
Hauteur parasol fermé

**E**- Altura manivela  
Crank height  
Hauteur manivelle

forma shape forme	medida measurement dimension	varillas ribs baleines	mástil pole mât	altura A height A hauteur A	altura B height B hauteur B	altura C height C hauteur C	altura D height D hauteur D	embalaje packaging emballage
	4m	8	100x100mm	225cm	282cm	162cm	364cm	40x40x367cm
	5m	8	100x100mm	225cm	314cm	160cm	421cm	40x40x424cm
	3x3m	8	100x100mm	225cm	293cm	166cm	384cm	40x40x387cm
	3'5x3'5m	8	100x100mm	225cm	291cm	153cm	403cm	40x40x406cm
	4x4m	8	100x100mm	225cm	296cm	134cm	420cm	40x40x423cm
	4'5x4'5m	8	100x100mm	225cm	309cm	95cm	418cm	40x40x403cm
	5x5m	8	100x100mm	225cm	319cm	87cm	447cm	40x40x450cm
	5'5x5'5m	8	100x100mm	225cm	329cm	60cm	456cm	40x40x459cm
	2x3m	8	100x100mm	225cm	273cm	154cm	334cm	40x40x337cm
	2x3'5m	8	100x100mm	225cm	284cm	147cm	349cm	40x40x352cm
	2x4m	8	100x100mm	225cm	279cm	143cm	367cm	40x40x370cm
	2'5x3m	8	100x100mm	225cm	263cm	178cm	370cm	40x40x373cm
	2'5x3'5m	8	100x100mm	225cm	278cm	159cm	373cm	40x40x376cm
	2'5x4m	8	100x100mm	225cm	282cm	142cm	377cm	40x40x380cm
	2'5x4'5m	8	100x100mm	225cm	287cm	123cm	380cm	40x40x383cm
	2'5x5m	8	100x100mm	225cm	293cm	127cm	407cm	40x40x410cm
	3x3'5m	8	100x100mm	225cm	291cm	161cm	393cm	40x40x396cm
	3x4m	8	100x100mm	225cm	265cm	133cm	378cm	40x40x381cm
	3x4'5m	8	100x100mm	225cm	291cm	130cm	400cm	40x40x403cm
	3x5m	8	100x100mm	225cm	309cm	131cm	427cm	40x40x430cm
	3x6m	8	100x100mm	225cm	324cm	101cm	443cm	40x40x446cm
	3'5x4m	8	100x100mm	225cm	315cm	139cm	412cm	40x40x415cm
	3'5x4'5m	8	100x100mm	225cm	300cm	126cm	413cm	40x40x416cm
	3'5x5m	8	100x100mm	225cm	316cm	122cm	434cm	40x40x437cm
	3'5x6m	8	100x100mm	225cm	327cm	92cm	446cm	40x40x449cm
	4x4'5m	8	100x100mm	225cm	308cm	120cm	425cm	40x40x428cm
	4x5m	8	100x100mm	225cm	341cm	135cm	468cm	40x40x471cm
	4x5'5m	8	100x100mm	225cm	327cm	100cm	449cm	40x40x452cm
4'5x5m	8	100x100mm	225cm	319cm	94cm	436cm	40x40x439cm	
4'5x5'5m	8	100x100mm	225cm	328cm	91cm	452cm	40x40x455cm	
5x5'5m	8	100x100mm	225cm	335cm	82cm	462cm	40x40x465cm	



# SERIE BERLIN DESPLAZADO

Parasol de aluminio  
Aluminium parasol  
Parasol en aluminium

## ES

Parasol con las mismas características del Berlin, con la diferencia de su mástil situado a 50cm del lateral. Al ser un parasol con un mástil de 100x100mm, nos permite fabricar mayores dimensiones. Permite crear grandes espacios cubiertos, sin la molestia de un mástil central. Ideal para aprovechar al máximo el espacio de tu terraza.

## EN

Everything in this parasol is the same as the Berlin model but its pole is located 50cm from the side. Being a parasol with a 100x100mm pole, it allows for larger dimensions. This model enables us to create large covered spaces without the inconvenience of a central pole. It is ideal for making the most of your terrace space.

## FR

Parasol avec les mêmes caractéristiques que le Berlin, avec la différence de son mât situé à 50cm du côté. Puisque c'est un parasol avec un mât de 100x100mm, il nous permet de fabriquer des dimensions plus grandes. Il facilite la création de grands espaces couverts, sans les inconvénients d'un mât central. Ce parasol est idéal pour profiter au maximum de votre espace terrasse.

Mástil **TELESCÓPICO** Apertura **MANIVELA con husillo**  
Pole **TELESCOPIC** Opening **CRANK with endless screw**  
Mât **TÉLESCOPIQUE** Ouverture **MANIVELLE avec vis sans fin**

## Opciones / Options / Options

Acabados  
Finishes  
Finitions

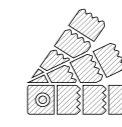

ref. **TAS/TPS**  
p. 84-87

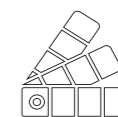

p.80



p.82

Accesorios  
Accessories  
Accessoires

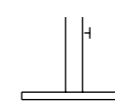

p.64-69

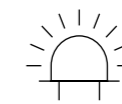

p.70-73



p.72



p.74

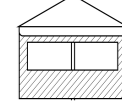

p.76

**Características / Features / Caractéristiques**

SERIE  
**BERLIN DESPLAZADO**

Corona de aluminio y colante de polietileno con soporte inox para las varillas.

Aluminium notch and polyethylene runner with inox brackets for ribs.

Noix en aluminium et coulant en polyéthylène avec support de baleine en inox.



Mástil de 100x100mm. (3mm de grosor)  
Estructura de aluminio lacado blanco.  
Sistema telescópico con manivela.

100x100mm pole. (3mm thick).  
White coated aluminium frame  
Telescopic opening system with crank.

Mât de 100x100mm. (3mm d'épaisseur)  
Monture en aluminium laqué blanc.  
Système télescopique avec manivelle.



Varillas perfil 20x40mm.  
Sujeción individual mediante tornillos.

Section 20x40mm ribs.  
Attached individually by screws.

Profile 20x40mm.  
Fixation individuelle par vis.

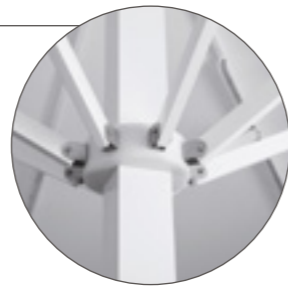

**Bases recomendadas / Suggested bases / Bases recommandées**



Fijar 20  
Fix 20  
Fixar 20



Base de baldosas  
Tiles base  
Base delles



Base jardinera  
Planter base  
Base jardinière



Bases para empotrar  
Built in bases  
Bases à encaster

TODAS LAS BASES /

ALL BASES /

TOUTES BASES

— p.64

**Tabla de medidas / Available sizes / Tableau de mesures**

SERIE  
**BERLIN DESPLAZADO**

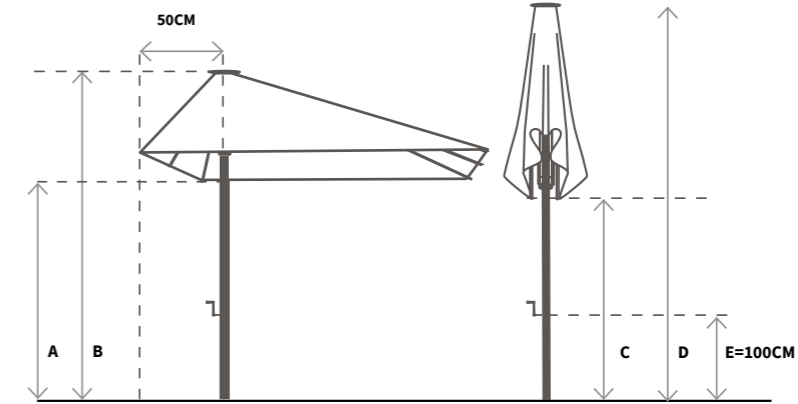

- A** - Altura varilla abierto  
Rib height open  
Hauteur baleine ouvert
- B** - Altura parasol abierto  
Open parasol height  
Hauteur parasol ouvert
- C** - Altura varilla cerrado  
Rib height closed  
Hauteur baleine fermé
- D** - Altura parasol cerrado  
Closed parasol height  
Hauteur parasol fermé
- E** - Altura manivela  
Crank height  
Hauteur manivelle

forma shape forme	medida measurement dimension	varillas ribs baleines	mástil pole mât	altura A height A hauteur A	altura B height B hauteur B	altura C height C hauteur C	altura D height D hauteur D	embalaje packaging emballage
-------------------------	------------------------------------	------------------------------	-----------------------	-----------------------------------	-----------------------------------	-----------------------------------	-----------------------------------	------------------------------------

	2,5x2,5m	6	100x100mm	225cm	285cm	185cm	367cm	40x40x368cm
	3x3m	6	100x100mm	225cm	306cm	106cm	402cm	40x40x406cm

	2x2'5m	6	100x100mm	225cm	271cm	171cm	365cm	40x40x368cm
	2x3m	6	100x100mm	225cm	271cm	129cm	381cm	40x40x384cm
	2x3'5m	6	100x100mm	225cm	282cm	146cm	377cm	40x40x380cm
	2x4m	6	100x100mm	225cm	277cm	132cm	380cm	40x40x383cm
	2x4'5m	6	100x100mm	225cm	283cm	123cm	393cm	40x40x396cm
	2'5x3m	6	100x100mm	225cm	279cm	152cm	400cm	40x40x403cm
	2'5x3'5m	6	100x100mm	225cm	287cm	144cm	410cm	40x40x413cm
	2'5x4m	6	100x100mm	225cm	294cm	134cm	419cm	40x40x421cm
	2'5x4'5m	6	100x100mm	225cm	302cm	106cm	410cm	40x40x413cm
	2,5x5m	6	100x100mm	225cm	313cm	92cm	417cm	40x40x420cm
	3x3,5m	6	100x100mm	225cm	310cm	104cm	413cm	40x40x416cm
	3x4m	6	100x100mm	225cm	314cm	93,2cm	417cm	40x40x420cm
	3x4,5m	6	100x100mm	225cm	318cm	95,6cm	437cm	40x40x440cm



# SERIE GOLD EXTRA

Parasol mixto de madera y aluminio  
Mixed wood and aluminum parasol  
Parasol mixte bois et aluminium

ES

Parasol resistente y de mayores dimensiones gracias a sus sólidas varillas de aluminio imitación madera. Junto con el mástil, el colante y la corona de madera, proyectan una imagen totalmente rústica. Es ideal para crear un entorno rural.

EN

Strong and larger parasol thanks to its solid aluminium ribs in wood imitation. Along with the pole, the runner and the notch all made of wood, this model displays an absolutely rustic style. It is ideal for creating a rural environment.

FR

Parasol robuste et plus grand grâce à ses baleines résistantes en aluminium imitation bois. Avec le mât, le coulant et la noix en bois, ce modèle projette une image totalement rustique. Il est idéal pour créer un environnement rural.



Varillas de aluminio imitación madera de perfil 20x30mm.  
Mástil de ø60mm de madera tropical de color nogal medio.

Wood imitation aluminum ribs 20x30mm profile.  
ø60mm pole in tropical hard wood in walnut color.

Profil 20x30mm aluminium imitation bois.  
Mât ø60mm en bois tropical en couleur noyer.

Sistema de apertura con 2 poleas dobles.  
Colante y corona de madera.

Opening system by 2 double pulley.  
Wood runner and notch.

Système d'ouverture par 2 poulies doubles.  
Coulant et noix en bois.

## Opciones / Options / Options

Acabados  
Finishes  
Finitions

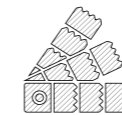

ref. TOP / TAS  
p. 84-87

p.82

Accesorios  
Accessories  
Accessoires

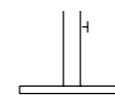

p.64-69

## Medidas / Measures / Mesures

Forma  
Shape  
Forme

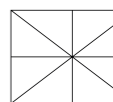
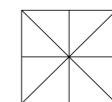
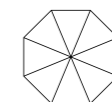

ø3m	2x2m	2x3m
ø3.5m	2.5x2.5m	3x4m
ø4m	3x3m	
ø5m	3.5x3.5m	
	4x4m	

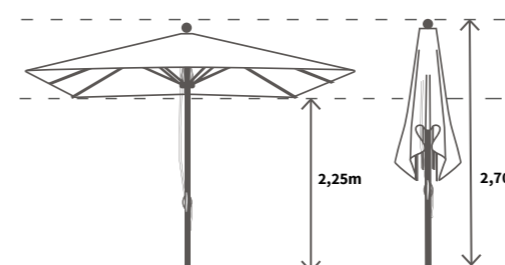

20-35Kg





# SERIE LUXE

**Parasol mixto de madera y aluminio**  
**Mixed wood and aluminum parasol**  
**Parasol mixte bois et aluminium**

ES

Parasol fuerte y robusto caracterizado por su mástil cuadrado de madera y su elegante colante de madera. Es un parasol idóneo para darle un ambiente rústico y cálido a su lujosa terraza.

EN

Strong and robust parasol featuring a square wooden pole and elegant wooden runner. It is an ideal parasol to provide your luxurious terrace with a rustic and warm atmosphere.

FR

Parasol robuste et solide caractérisé par son mât carré en bois et son élégant coulant en bois. C'est un parasol idéal pour donner une ambiance rustique et chaleureuse à votre terrasse luxueuse.

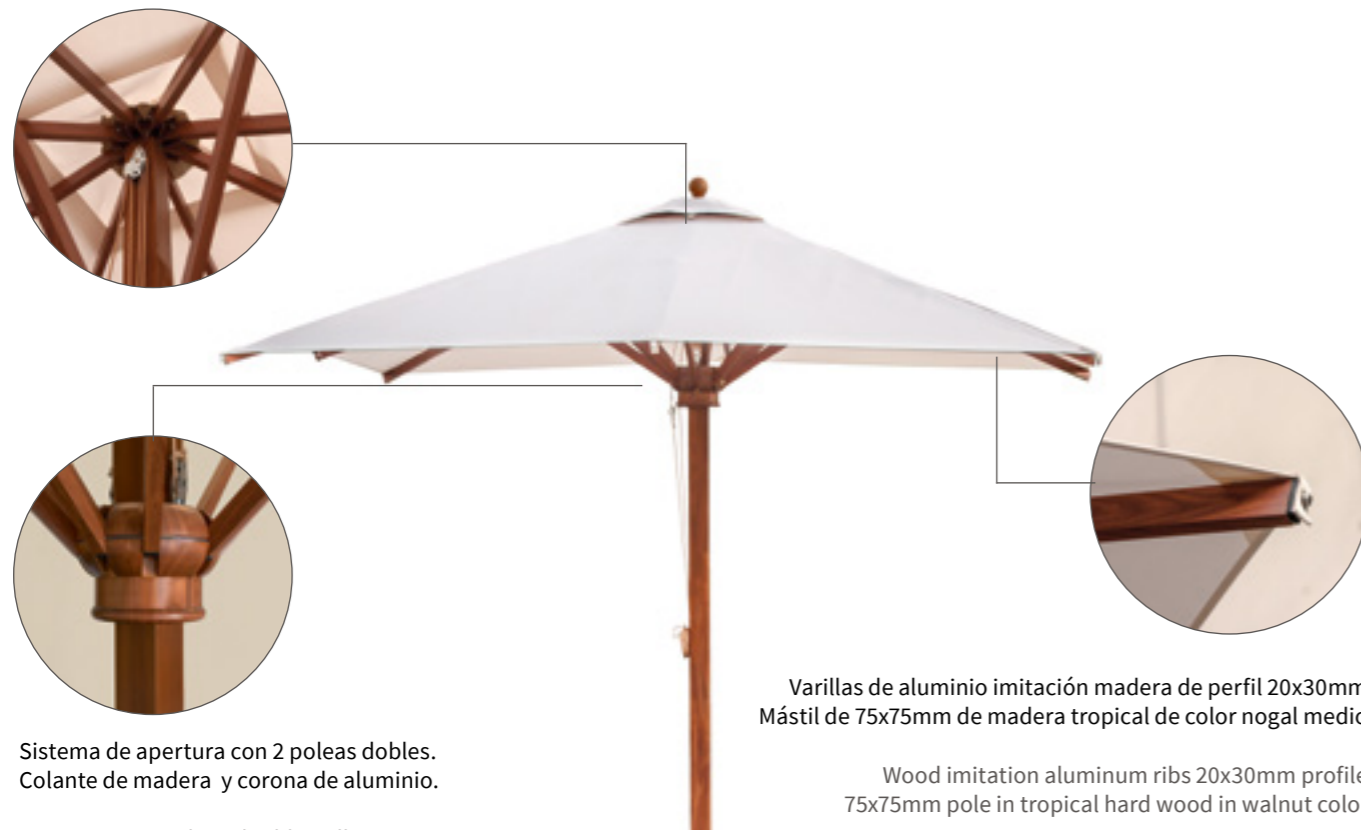

Sistema de apertura con 2 poleas dobles.  
 Colante de madera y corona de aluminio.

Opening system by 2 double pulleys.  
 Wood runner and aluminium notch.

Système d'ouverture par 2 poulies doubles.  
 Coulant en bois et noix en aluminium.

Varillas de aluminio imitación madera de perfil 20x30mm.  
 Mástil de 75x75mm de madera tropical de color nogal medio.

Wood imitation aluminum ribs 20x30mm profile.  
 75x75mm pole in tropical hard wood in walnut color.

Profil 20x30mm aluminium imitation bois.  
 Mât 75x75mm en bois tropical en couleur noyer.

## Opciones / Options / Options

Acabados  
 Finishes  
 Finitions

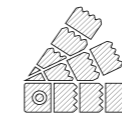

ref. TOP / TAS  
 p. 84-87

p.82

Accesorios  
 Accessories  
 Accessoires

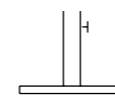

p.64-69

## Medidas / Measures / Mesures

Forma  
 Shape  
 Forme

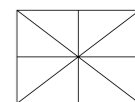
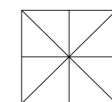
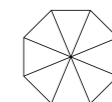

ø3.5m

3x3m

2x3m

ø4m

3.5x3.5m

3x4m

ø5m

4x4m

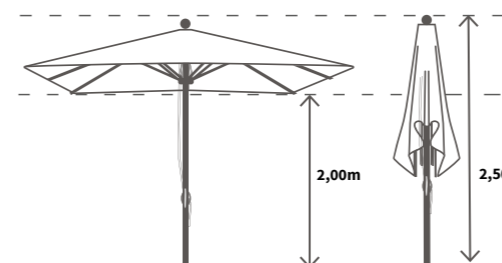



# SERIE CLASSIC

**Parasol de madera**  
**Wood parasol**  
**Parasol en bois**

ES

Parasol ligero y de dimensiones reducidas, ideal para recoger a diario. Tiene un diseño cálido y coqueto, perfecto para adaptarse en los entornos naturales más bonitos.

EN

Lightweight, small-sized parasol, ideal for picking up every day. It has a warm and charming design that fits perfectly in the most beautiful natural environments.

FR

Parasol léger de petite taille, idéal pour ranger chaque jour. Il a un design chaleureux et flirtant, parfait pour s'intégrer dans les plus beaux environnements naturels.



Sistema de apertura mediante 2 poleas.  
 Colante y corona de plástico.

Opening system by 2 pulley.  
 Plastic runner and notch.

Système d'ouverture par 2 poulies.  
 Coulant et noix en plastique.

Varillas de madera de perfil 17-22mm/ 20-28mm  
 Mástil de ø38/48mm.  
 En madera tropical color nogal medio.

17-22mm/20-28mm profile wood ribs.  
 ø38/48mm pole.  
 Tropical hard wood in walnut color.

Tiges en bois profilées 17-22mm/ 20-28mm  
 Mât ø38/48mm.  
 En bois tropical noyer moyen.

## Opciones / Options / Options

Acabados  
 Finishes  
 Finitions

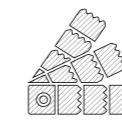

ref. TPA / TOP  
 p. 84-87

p.82

Accesorios  
 Accessories  
 Accessoires

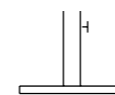

p.64-69

## Medidas / Measures / Mesures

Forma  
 Shape  
 Forme

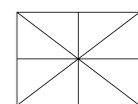
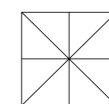
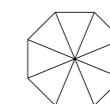

ø2m

2x2m

2x3m

ø2.4m

2.5x2.5m

ø3m

3x3m

ø3.5m

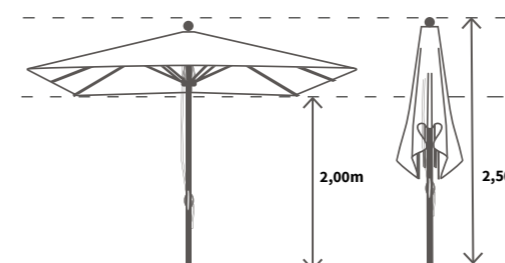

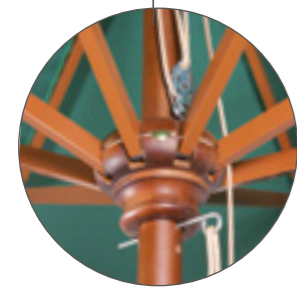

Sistema de apertura con 2 poleas.  
Colante y corona de madera.

Opening system by 2 pulley.  
Wood runner and notch.

Système d'ouverture par 2 poulies.  
Coulant et noix en bois.



Varillas de aluminio RAL marrón de perfil 15x25mm.  
Mástil de ø50mm madera tropical en color nogal medio.

15x25mm profile ribs in RAL brown aluminum.  
ø50mm tropical hard wood in walnut colour.

Tiges en aluminium marrón RAL avec profil 15x25mm.  
Mât en bois tropical de ø50 mm de couleur noyer.

# SERIE NIZA

**Parasol mixto de madera y aluminio**  
**Mixed wood and aluminum parasol**  
**Parasol mixte bois et aluminium**

ES

Parasol ligero ideal para los amantes de la madera que buscan solidez en sus parasoles. Las varillas de aluminio marrón se mimetizan con la naturaleza, obteniendo así la calidez de la madera con la resistencia del aluminio.

EN

Lightweight parasol that is ideal for wood lovers looking for solidity in their parasols. The brown aluminium ribs blend in with nature, thus obtaining the warmth of wood combined with the strength of aluminium.

FR

Parasol léger idéal pour les amoureux du bois qui recherchent la solidité dans leurs parasols. Les baleines d'aluminium marron se mélangent avec la nature pour offrir la chaleur du bois avec la force de l'aluminium.

## Opciones / Options / Options

Acabados  
Finishes  
Finitions

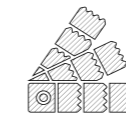

ref. TPA/TOP/TAS  
p. 84-87

p.82

Accesorios  
Accessories  
Accessoires

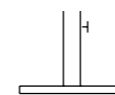

p.64-69

## Medidas / Measures / Mesures

Forma  
Shape  
Forme

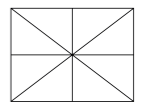
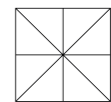
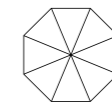

ø2m	2x2m	2x2.5m
ø2.4m	2.5x2.5m	2x3m
ø3m	3x3m	2.5x3m
ø3.5m		
ø4m		

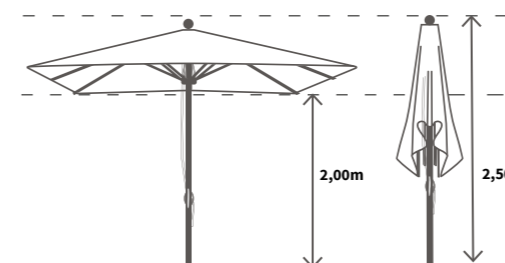



# SERIE BASIC

Parasol de madera  
Wood parasol  
Parasol en bois

**ES**

Parasol de madera ligero. El mástil es desmontable en dos piezas, ideal para poder guardar en espacios muy reducidos. Este parasol se puede utilizar tanto en pequeñas terrazas, como para uso particular. Disponible en tejido spunpoly crudo (servicio inmediato) y en tejido polisilk con nuestros colores de stock.

**EN**

Lightweight wooden parasol whose pole is detachable in two parts, ideal for storage in very small spaces. This parasol can be used both in small terraces and for private use. It is available in spunpoly fabric in ecru color (quick service) and in polisilk fabric with our stock colours.

**FR**

Parasol léger en bois. Le mât est démontable en deux parties, idéale pour le stockage dans des espaces très réduits. Ce parasol peut être utilisé aussi bien sur de petites terrasses que pour l'usage privé. Disponible en tissu spunpoly couleur crème (service immédiat) et en tissu polisilk en nos couleurs de stock.



Colante y corona de plástico.  
Plastic runner and notch.  
Coulant et noix en plastique.

Varillas de perfil 17x22mm.  
Sujeción conjunta mediante alambre.

Section 17x22mm ribs.  
Attached together by wire.

Profil 17x22mm.  
Fixation conjointe par fil de fer.

Madera tropical de importación.  
Mástil de ø48mm.  
Sistema de apertura con 2 poleas.

Import tropical hard wood. ø48mm pole.  
Pulley opening system

Bois en tropical d'importation.  
Mât en ø48mm.  
Système d'ouverture par deux poulies.

## Opciones / Options / Options

Acabados  
Finishes  
Finitions

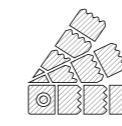

ref. TPA / TOP  
p. 84-87

p.82

Accesorios  
Accessories  
Accessoires

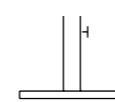

p.64-69

## Medidas / Measures / Mesures

Forma  
Shape  
Forme

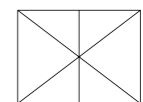
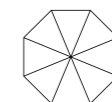

ø3m

2x3m



Color de stock  
Stock color  
Couleur de stock

CREMA  
Spunpoly

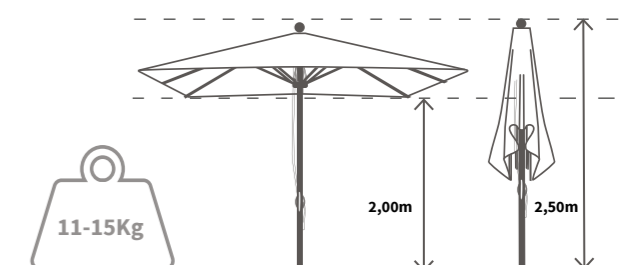



# SERIE POOL MADERA

Parasol de madera  
Wood parasol  
Parasol en bois

ES

Parasol en forma decagonal y cuadrado ideal para tu piscina. Se fabrica en tejido polisilk con nuestros colores de stock y posibilidad de acabado con flecos.

EN

Decagonal and square parasol that is ideal for your pool. It is manufactured in polisilk fabric with our stock colors.

FR

Parasol décagonal et carré idéal pour votre piscine. Il est fabriqué en tissu polisilk en nos couleurs de stock.



Decagonal: 10 varillas de fibra Ø8mm.  
Cuadrado: 8 varillas de fibra Ø8mm.

Decagonal: 10 fiber ribs Ø8mm.  
Square: 8 fiber ribs Ø8mm.

Décagonal: 10 baleines en fibre Ø8mm.  
Carré: 8 baleines en fibre Ø8mm.

Mástil madera color nogal.  
Wood pole walnut color.  
Poteau en bois couleur noyer.

## Opciones / Options / Options

Acabados  
Finishes  
Finitions

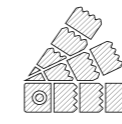

ref. TPA / TOP  
p. 84-87

p.82

Accesorios  
Accessories  
Accessoires

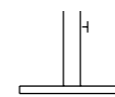

p.64-69

## Medidas / Measures / Mesures

Forma  
Shape  
Forme

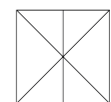
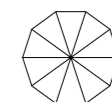

Ø2m

2x2m

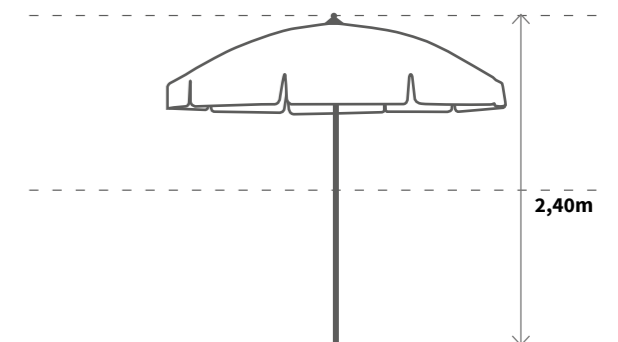

# SERIE POOL

## Aluminio estriado

**ES**  
Parasol en forma decagonal y cuadrado ideal para tu piscina. Se fabrica en tejido polisilk con nuestros colores de stock.

**EN**  
Decagonal and square parasol that is ideal for your pool. It is manufactured in polisilk fabric with our stock colors.

**FR**  
Parasol décagonal et carré idéal pour votre piscine. Il est fabriqué en tissu polisilk en nos couleurs de stock.



Mástil estriado de aluminio color plata de Ø36-40mm.  
De 2 piezas y altura regulable. No inclinable.

Ø36-40mm. Aluminium fluted pole silver color.  
Height adjustable two piece pole. Non-tiltable.

Mât strié en aluminium Couleur argent Ø36-40mm.  
Mât de 2 pièces et hauteur réglable. Non reclinable.

Decagonal: 10 varillas de fibra Ø8mm.  
Cuadrado: 8 varillas de fibra Ø8mm.

Decagonal: 10 fiber ribs Ø8mm.  
Square: 8 fiber ribs Ø8mm.

Décagonal: 10 baleines en fibre Ø8mm.  
Carré: 8 baleines en fibre Ø8mm.

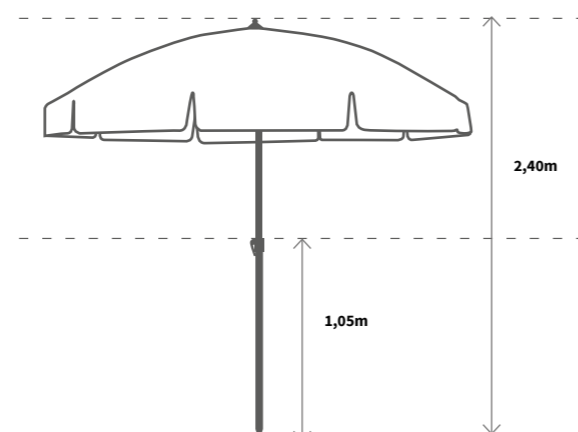

Opcional  
Optional  
Optionnel

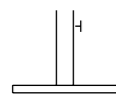

p.64-69

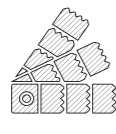

ref. TPA / TOP  
p. 84-87



p.82

Medidas  
Measures  
Mesures

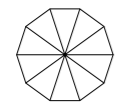

2m

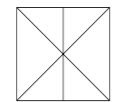

2x2m

# SERIE SINTRA



Funda de protección incluida.  
Protection cover included.  
Housse de protection incluse.

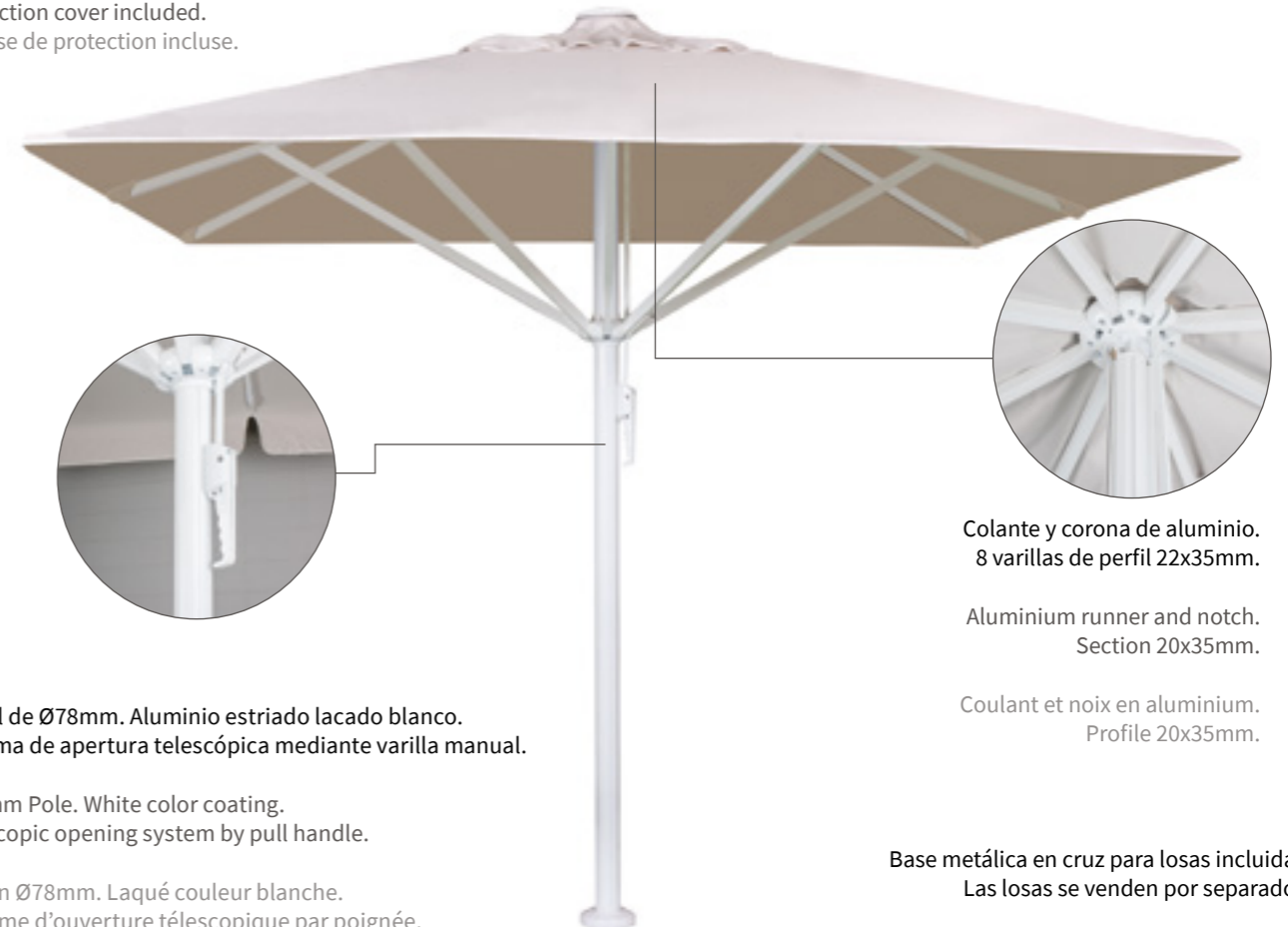

Mástil de Ø78mm. Aluminio estriado lacado blanco.  
Sistema de apertura telescópica mediante varilla manual.

Ø78mm Pole. White color coating.  
Telescopic opening system by pull handle.

Mât en Ø78mm. Laqué couleur blanche.  
Système d'ouverture télescopique par poignée.

Colante y corona de aluminio.  
8 varillas de perfil 22x35mm.

Aluminium runner and notch.  
Section 20x35mm.

Coulant et noix en aluminium.  
Profile 20x35mm.

Base metálica en cruz para losas incluida.  
Las losas se venden por separado.

Metal cross base structure for slabs included.  
The slabs are sold separately.

Base métallique en croix pour dalles incluse.  
Les dalles sont vendues séparément.

Opcional  
Optional  
Optionnel

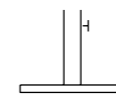

p.64-69



p.82

Tejido color  
Fabric color  
Tissu couleur

**MARFIL**  
Poliester  
300g/m<sup>2</sup>  
ref. Poliester

**SIN VOLANTE**  
WITHOUT VALANCE  
SANS VOLANT

Medidas  
Measures  
Mesures

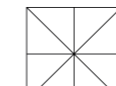

4x4m

5x5m

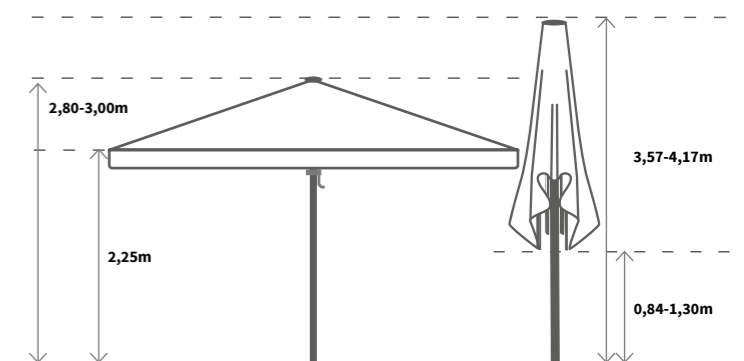

# SERIE STREET



Montura acabado lacado gris.  
Gray coated frame.  
Monture finition laqué grise.



Mástil de Ø48/50mm.  
Sistema de apertura de poleas.

Ø48/50mm Pole.  
Opening system by pulleys.

Mât en ø48/50mm.  
Système d'ouverture par poulie.

Colante y corona de plástico.  
8 varillas de 15x25mm.

Plastic runner and notch.  
8 ribs 15x25mm.

Coulant et noix en plastique.  
8 baleines 15x25mm.

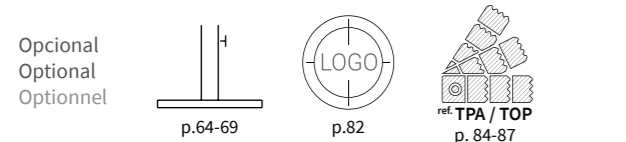

Tejido color  
Fabric color  
Tissu couleur

**MARFIL**  
Poliester  
235g/m<sup>2</sup>  
ref. Poliester



Medidas  
Measures  
Mesures

2x2m      2x3m

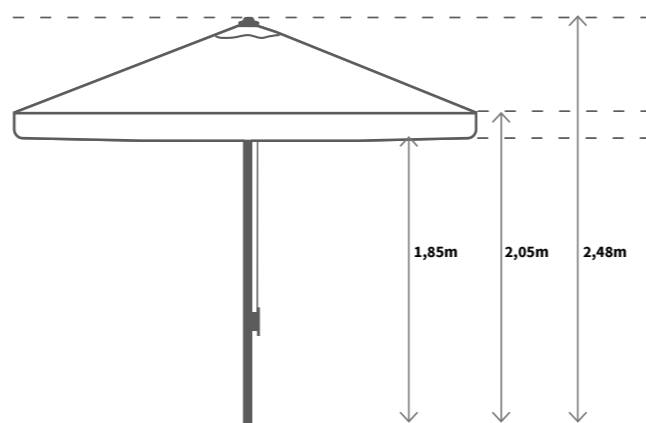

ES

Parasol disponible en tejido poliéster color natural (servicio inmediato) y en tejido polisilk con nuestros colores de stock. Se trata de un parasol ligero y fácil de manejar. Es ideal para eventos, ceremonias al aire libre y para el uso particular.

EN

Parasol available in natural colored polyester fabric (quick service) and in polisilk fabric with our stock colors. It is a lightweight and easy to handle model. This parasol is ideal for events, outdoor ceremonies and for private use.

FR

Parasol disponible en tissu polyester de couleur naturelle (service immédiat) et en tissu polisilk en nos couleurs de stock. C'est un parasol léger et facile à manipuler. Il est idéal pour des événements, des cérémonies en plein air et pour l'usage privé.

Montura acabado anodizado gris.  
Anodisen gray aluminium frame.  
Monture finition anodisée grise.

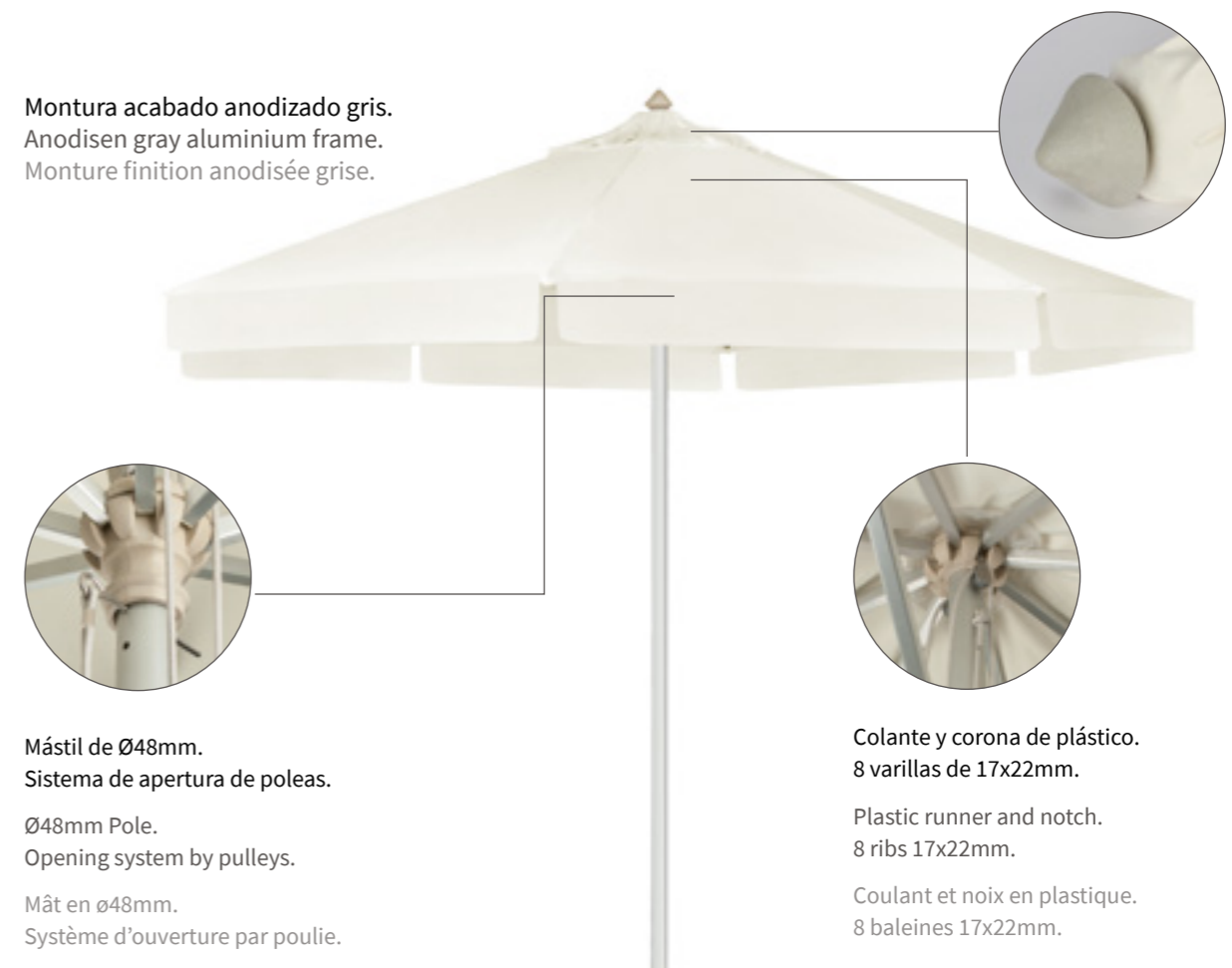

Mástil de Ø48mm.  
Sistema de apertura de poleas.

Ø48mm Pole.  
Opening system by pulleys.

Mât en ø48mm.  
Système d'ouverture par poulie.

Colante y corona de plástico.  
8 varillas de 17x22mm.

Plastic runner and notch.  
8 ribs 17x22mm.

Coulant et noix en plastique.  
8 baleines 17x22mm.

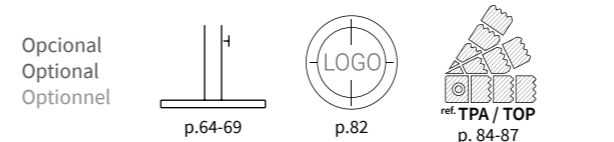

Tejido color  
Fabric color  
Tissu couleur

**MARFIL**  
Poliester  
235g/m<sup>2</sup>  
ref. Poliester



Medidas  
Measures  
Mesures

3m

# Bases

## Bases / Bases

### Base de polietileno rellenable / Refill polythene base / Polythene base rechargeable

	Base de superficie Surface base Base de surface		
	Con el tubo desmontable. Rellenable With removable tube. Refillable Avec tube démontable. Rechargeable		
	Color Colour Couleur		
	Peso Weight Lester	<b>1,2kg – 15kg</b>	

Para / For / Pour : SERIE POOL

### Base hormigón / Concrete base / Base de béton

	Base de superficie Surface base Base de surface		
	Con el tubo fijo With fixed tube Avec tube fixe		
	Color Colour Couleur		
	Peso Weight Lester	<b>15kg</b>	

Para / For / Pour : SERIE POOL - CLASSIC (2M-6)

### Hormigón recubierto / Coated concrete/ Béton enduit

	Base de superficie Surface base Base de surface		
	Con el tubo desmontable With removable tube Avec tube démontable		
	Color Colour Couleur		
	Peso Weight Lester	<b>30kg</b>	

Para / For / Pour : SERIE POOL - STREET - BASIC - CLASSIC - ESTANDAR - NIZA - NATURFUST

### Hormigón recubierto y ruedas / Coated concrete and wheels/ Béton enduit et roues

	Base de superficie Surface base Base de surface		
	Con el tubo desmontable y ruedas With removable tube and wheels Avec tube démontable et roues		
	Color Colour Couleur		
	Peso Weight Lester	<b>40kg</b>	

Para / For / Pour : SERIE POOL - STREET - BASIC - CLASSIC - ESTANDAR - NIZA - NATURFUST

### Base de granito / Granite base / Base de granit

	Base de superficie Surface base Base de surface		
	Con el tubo desmontable With removable tube Avec tube démontable		
	Color Colour Couleur		
	Peso Weight Lester	<b>35 / 50kg</b>	

Para / For / Pour : SERIE CLASSIC - BASIC - ESTANDAR - NIZA - GOLD EXTRA



### Resinada rellenable / Refill resined / Résine rechargeable

	Base de superficie Surface base Base de surface		
	Con el tubo desmontable. Rellenable With removable tube. Refillable Avec tube démontable. Rechargeable		
	Colores Couleurs Couleurs		
	Peso Weight Lester	<b>5kg – 70kg</b>	

Para / For / Pour : GOLD EXTRA - ESTANDAR - ESTANDAR EXTRA

### Metálica 65-6 / Metallic 65-6 / Métallique 65-6

	Base de superficie Surface base Base de surface		
	Con el tubo fijo With fixed tube Avec tube fixe		
	Colores Couleurs Couleurs		
	Peso Weight Lester	<b>23kg</b>	

Para / For / Pour : SERIE BASIC - CLASSIC - ESTANDAR - NIZA

### Metálica 65 / Metallic 65 / Métallique 65

	Base de superficie Surface base Base de surface		
	Con el tubo desmontable With removable tube Avec tube démontable		
	Colores Couleurs Couleurs		
	Peso Weight Lester	<b>35kg / 55kg / 75kg / 105kg</b>	



Para / For / Pour : TODAS LAS SERIES - ALL SERIES - TOUTES LES SÉRIES

### Base jardinera / Planter base / Base jardinière

	Base de superficie Surface base Base de surface		
	Con el tubo desmontable y ruedas With removable tube and wheels Avec tube démontable et roues		
	Colores Couleurs Couleurs		
	Peso Weight Lester	<b>50x50x50cm = 50kg / 200kg</b> (llena / full / pleine) <b>65x65x50cm = 65kg / 250kg</b> (llena / full / pleine) <b>65x65x73cm = 80kg / 400kg</b> (llena / full / pleine)	

Para / For / Pour : TODAS LAS SERIES - ALL SERIES - TOUTES LES SÉRIES

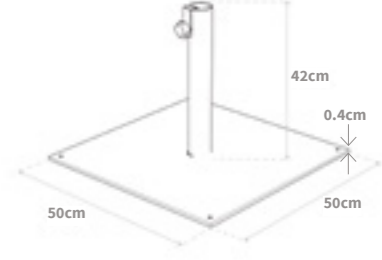
### Fijar 10 / Fix 10 / Fixer 10

	Base para fijar al suelo Base to fix the ground Base à fixer au sol		
	Con el tubo fijo With fixed tube Avec tube fixe		
	Colores Couleurs Couleurs		
	Peso Weight Lester	<b>10kg</b>	



Para / For / Pour : SERIE STREET - CLASSIC - ESTANDAR - ESTANDAR EXTRA- NIZA - NATURFUST

### Fijar 20 / Fix 20 / Fixer 20

	Base para fijar al suelo Base to fix the ground Base à fixer au sol		
	Con el tubo fijo With fixed tube Avec tube fixe		
	Colores Couleurs Couleurs		
	Peso Weight Lester	<b>20kg</b>	

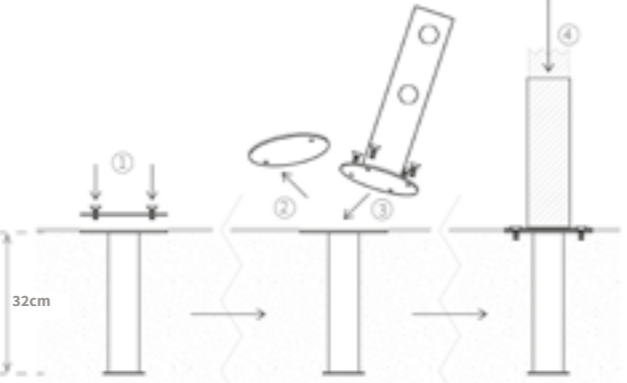

Para / For / Pour : TODAS LAS SERIES - ALL SERIES - TOUTES LES SÉRIES

**Empotrar 3 piezas / Built-in base 3 pieces / Encastrar, 3 pièces**

		
	Colores Colours Couleurs	

Para / For / Pour : TODAS LAS SERIES - ALL SERIES - TOUTES LES SÉRIES

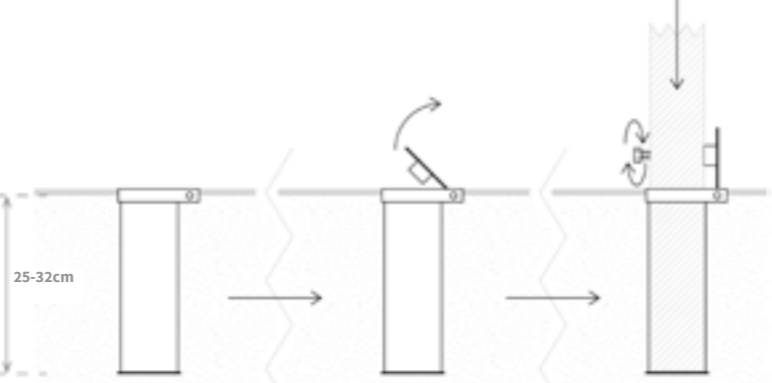
**Empotrar con tapa abatible / Built-in base with lid / Encastrée avec couvercle rabattable**

		
	Color Colour Couleur	

Para / For / Pour : SERIE ESTANDAR - ESTANDAR EXTRA - ELITE - PALMA - BERLIN

**PATENTADO**  
**PATENTED**  
**BRETEVÉ**

**Base 4 baldosas / 4 tiles base / Base 4 delles**

	Base de superficie Surface base Base de surface		
	Con el tubo desmontable With removable tube Avec tube démontable		
	Colores Colours Couleurs		
	Peso Weight Lester	90x90x4cm = 85kg 90x90x6cm = 110kg	Ruedas opcionales Optional wheels Roues optionnel

Para / For / Pour : TODAS LAS SERIES - ALL SERIES - TOUTES LES SÉRIES

**Base 8 baldosas / 8 tiles base / Base 8 delles**

	Base de superficie Surface base Base de surface		
	Con el tubo desmontable With removable tube Avec tube démontable		
	Colores Colours Couleurs		
	Peso Weight Lester	185kg	Ruedas opcionales Optional wheels Roues optionnel

Para / For / Pour : TODAS LAS SERIES - ALL SERIES - TOUTES LES SÉRIES

**Base XXL 250 / XXL 250 base / Base XXL 250**

	Base de superficie Surface base Base de surface		
	Con el tubo desmontable With removable tube Avec tube démontable		
	Colores Colours Couleurs		
	Peso Weight Lester	250kg	

Para / For / Pour : PARASOLES > 4,5X4,5M

# Iluminación

## Lighting / Éclairage

### Caja de conexión Connection box Boîte de jonction

Instalación eléctrica del parasol realizada en fábrica. Incluye el cableado interno del mástil y una caja con 4 conexiones 220V.

The parasol's wiring is carried out in the factory. It includes the pole's internal wiring and a box with 4 220V connections.

Installation électrique du parasol réalisée en usine. Comprend le câblage interne du mât et une boîte avec 4 connexions 220V.



### Kit tiras LED LED strips kit Kit rubans à LED

**El montaje va a cargo del cliente.** Kit de iluminación que incluye un enchufe, un transformador, un atenuador, un mando a distancia, una funda para guardar el transformador y el atenuador en el parasol y las 4 tiras LED a elegir entre las siguientes opciones. La funda se cuelga en las varillas o el mástil del parasol.

**The assembly is at the customer's expense.** The lighting kit includes a plug, a transformer, a dimmer, a remote control, a cover to keep the transformer and the dimmer in the parasol and the 4 LED strips to be chosen.

**Le montage est à la charge du client.** Ce kit d'éclairage comprend une prise, un transformateur, un variateur, une télécommande, un couvercle pour garder le transformateur et le variateur dans le parasol et les 4 rubans à LED au choix.

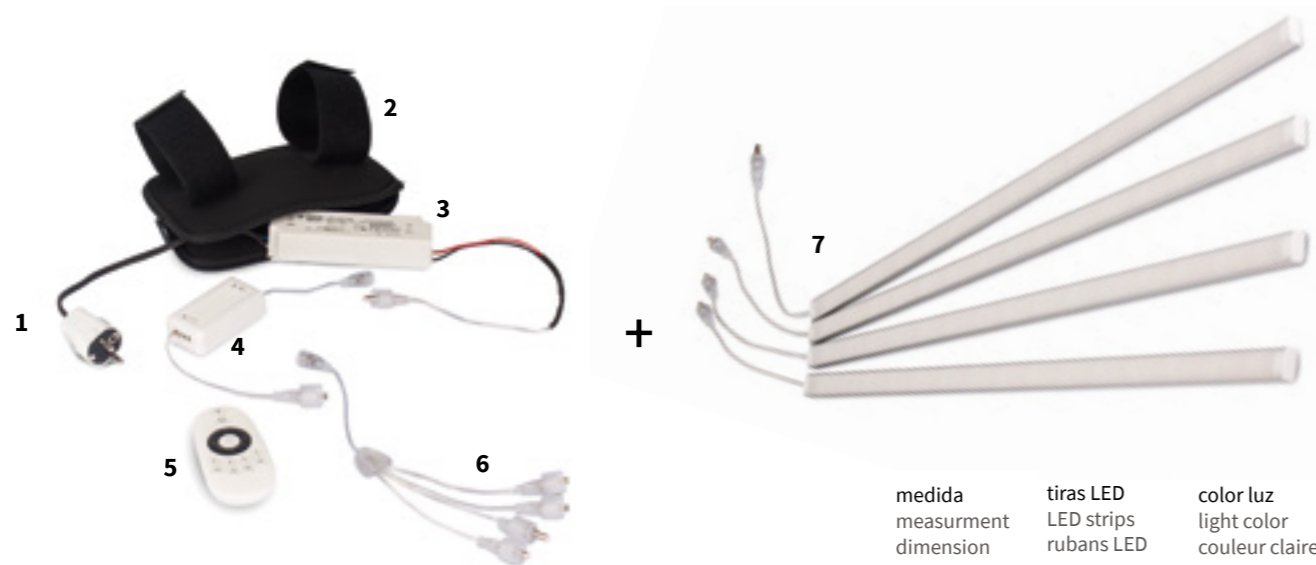

1. Enchufe / Plug / Prise
2. Funda con velcro / Cover with velcro / Couvercle velcro
3. Transformador / Transformer / Transformateur
4. Atenuador / Dimmer / Variateur
5. Mando a distancia / Remote control / Télécommande
6. Distribuidor / Distributor / Distributeur
7. Tiras LED / LED strips / Rubans à LED

medida measurement dimension	tiras LED LED strips rubans LED	color luz light color couleur claire
50cm	4	2700K
100cm	4	2700K
50cm	4	RGB
100cm	4	RGB

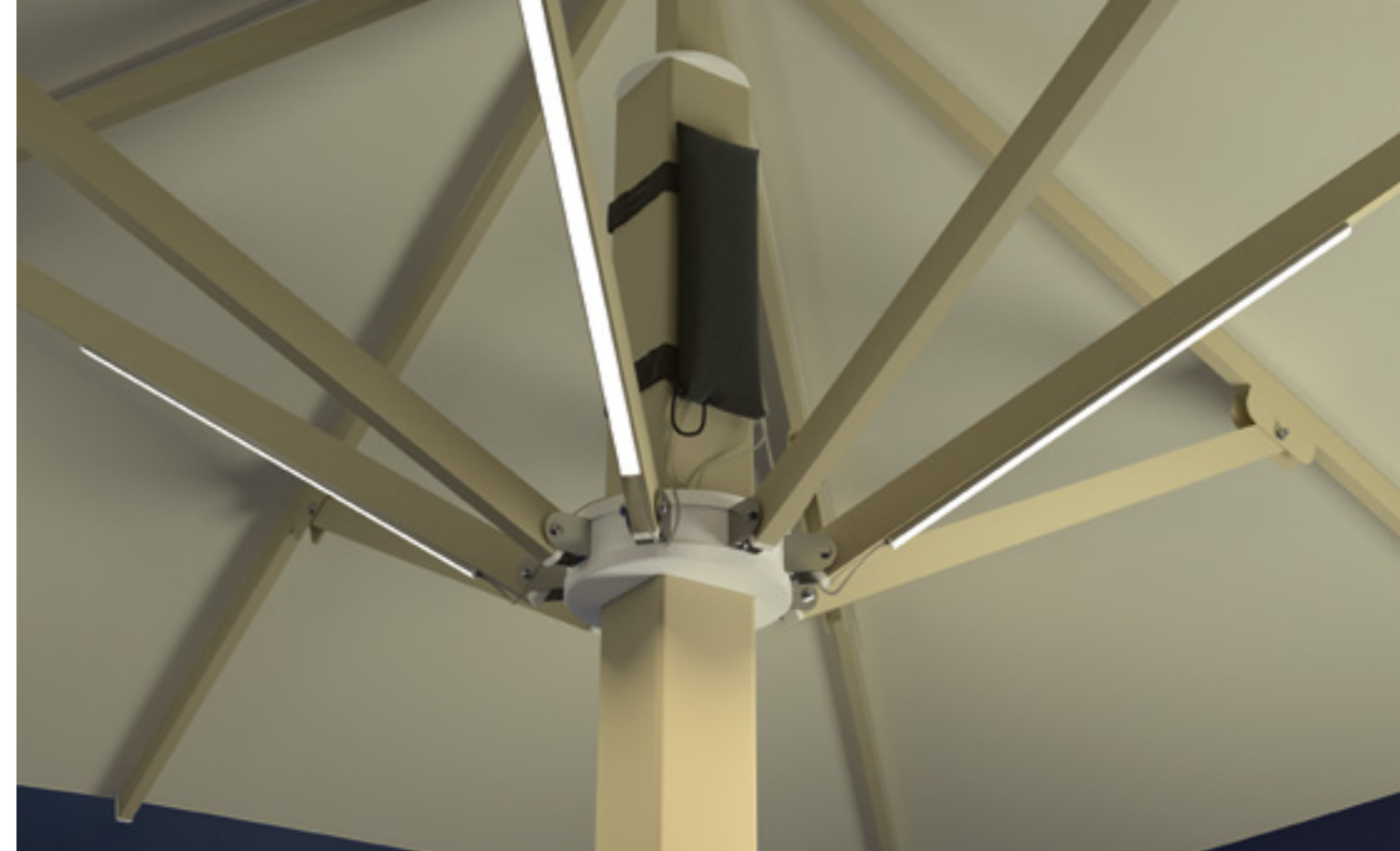

### Kit LED con batería LED kit with battery Kit LED avec batterie

**El montaje va a cargo del cliente.** Kit de iluminación que incluye batería, funda para la batería, un atenuador, un mando a distancia, un cargador para la batería y las 4 tiras LED. La funda se cuelga en las varillas o el mástil del parasol.

**The assembly is at the customer's expense.** The lighting kit includes a battery, a battery case, a dimmer, a remote control, a charger for the battery and the 4 LED strips.

**Le montage est à la charge du client.** Le kit d'éclairage comprend une batterie, un boîtier de batterie, un variateur, une télécommande, un couvercle pour maintenir la batterie et le variateur dans le parasol et les 4 bandes LED.

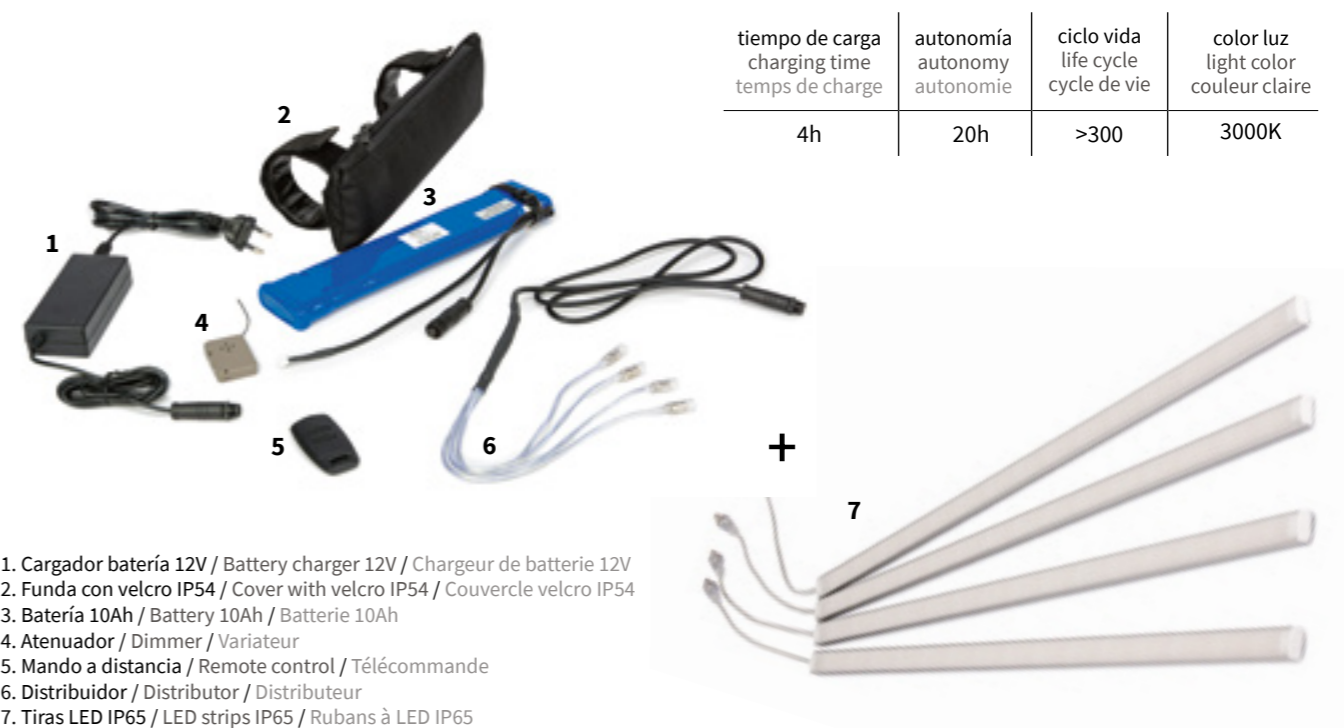

1. Cargador batería 12V / Battery charger 12V / Chargeur de batterie 12V
2. Funda con velcro IP54 / Cover with velcro IP54 / Couvercle velcro IP54
3. Batería 10Ah / Battery 10Ah / Batterie 10Ah
4. Atenuador / Dimmer / Variateur
5. Mando a distancia / Remote control / Télécommande
6. Distribuidor / Distributor / Distributeur
7. Tiras LED IP65 / LED strips IP65 / Rubans à LED IP65

tiempo de carga charging time temps de charge	autonomía autonomy autonomie	ciclo vida life cycle cycle de vie	color luz light color couleur claire
4h	20h	>300	3000K

# Iluminación

## Lighting / Éclairage



### Sistema de luz LED integrada

#### Built-in connection box

#### Boîte de jonction intégrée

Instalación eléctrica del parasol realizada en fábrica. Incluye el cableado interno del mástil, una caja con 2 conexiones, un interruptor, un mando y 4 tiras led a elegir entre las siguientes opciones:

The parasol's wiring is carried out in the factory. It includes the pole's internal wiring, a box with 2 connections, a switch, a remote control and 4 LED strips to choose from the following options:

Installation électrique du parasol réalisée en usine. Comprend le câblage interne du mât, une boîte avec 2 connexions, un interrupteur, une télécommande et 4 rubans à LED à choisir parmi les options suivantes:



Caja de conexión  
Connection box  
Boîte de jonction

2 conexiones de 220V  
4 conectores para tiras LED

2 220V connections  
4 connectors for LED strips

2 connexions 220V  
4 connecteurs pour bandes LED



Mando a distancia  
Remote control  
Télécommande



Tiras LED  
LED strips  
Rubans à LED

medida measurement dimension	tiras LED LED strips rubans à LED	color luz light color couleur claire
50cm	4	2700K
100cm	4	2700K
50cm	4	RGB
100cm	4	RGB

# Calefacción infrarojos

## Infrared heating / Chauffage infrarouge

Los calefactores infrarrojos son eficientes en energía porque no calientan el aire, sino que proporcionan calor a las personas que están cerca.  
Colocación debajo de las horquillas del parasol.

Infrared heaters are energy efficient as heat is projected directly to people around it, which makes heating the air unnecessary.  
Fitting at the support rib.

Le chauffage infrarouge est économe en énergie parce qu'il ne chauffe pas l'air, mais il fournit de la chaleur à ceux autour.  
Disposition aux côtes de parasol.

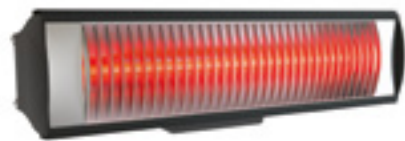

potencia power puissance	1,5 kw
--------------------------------	--------

protección protection protection	IP155
--	-------

cobertura coverage couverture	11m2
-------------------------------------	------

medidas measures mesures	48x12x12cm
--------------------------------	------------

peso weight poids	1,7 kg
-------------------------	--------

colores colors couleur	Blanco/Negro White/Black Blanc/Noir
------------------------------	---



# Fundas

## Case / Housses

### Funda protectora a juego con el parasol

#### Protective cover to match the parasol

#### Housse de protection assortie au parasol

#### Tejido

#### Fabric

#### Tissu

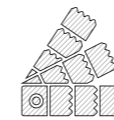

**Polisilk**  
200 g/m2  
ref. TOP

**Acrílico**  
300 g/m2  
ref. TAS

**PVC**  
400 g/m2  
ref. TPS

#### Para la serie:

#### For serie:

#### Pour série:

Estandar  
Estandar Extra  
Elite  
Elite Telescópico  
Elite Plus  
Elite Desplazado  
Palma  
Palma Desplazado  
Berlin  
Berlin Desplazado  
Luxe



### Funda protectora stock

#### Stock protection case

#### Housse protection stock

Recomendado para parasoles hasta 3x3m  
Recommended for parasols to 3x3m  
Recommandée pour parasol jusqu'à 3x3m

#### Para la serie:

#### For serie:

#### Pour série:

Niza  
Classic  
Gold extra  
Basic  
Street



# Cerramientos laterales

## Side screens / Bâches latérales

Instalación en las varillas del parasol.  
Tejido a juego con la cubierta del parasol.  
Ventana en PVC transparente lisa.  
Se suministra montado en las guías de aluminio y con todos los accesorios incluidos para la instalación.  
Opcional canaleta vierteaguas para unir los parasoles.  
Opcionales puntales de refuerzo.

Installation on parasol ribs.  
Same fabric as parasol.  
Windows in transparent PVC.  
Supplied in aluminum guides with all accessories for installation included.  
Optional gutters to join parasols.  
Optional reinforcement struts.

Installation sur les baleines.  
Tissu assorti à la couverture du parasol.  
Fenêtre en PVC transparent.  
Fournie déjà montée sur les rails en aluminium et avec tous les accessoires inclus pour l'installation.  
Optionnel gouttières pour joindre les parasols.  
Optionnel étais de force.

Los cerramientos dan un peso extra a las varillas de los parasoles, recomendamos el uso de puntales de refuerzo para asegurar la estabilidad de los parasoles.  
No se aconseja instalar cerramientos en todos los lados de los parasoles. Los parasoles no están fabricados para dejar los cerramientos permanentemente instalados y tampoco para utilizar como una estructura fija tipo carpa.

The side screens give extra weight to the ribs of the parasols, we recommend the use of reinforcement struts to ensure the stability of the parasols.  
It is not advisable to install side screens on all sides of the parasol. The parasols are not manufactured to leave side screens permanently installed and are not intended to be used as a fixed tent type structure.

Puisque les bâches ajoutent un poids supplémentaire aux baleines du parasol, nous recommandons l'utilisation des étais de force pour assurer la stabilité des parasols.  
Il n'est pas conseillé d'installer des bâches sur tous les côtés des parasols. Les parasols ne sont pas fabriqués pour y laisser les boîtiers installés de façon permanente et ne sont pas conçus pour être utilisés comme une structure fixe de type tente.

## Instalaciones / Installations / Les installations

Los parasoles se unen mediante canaletas vierteaguas y los cerramientos laterales mediante solapas con velcro.  
Los volantes inferiores tienen que sobrar para salvar irregularidades del terreno si conviene.  
Se pueden fabricar medidas especiales para adecuarlos a la instalación que precise.

Parasols are joined by rain gutters and the side screens by velcro flaps.  
The lower valance have to be left to save irregularities of the terrain if appropriate.  
We manufacture special measures to adapt them to the installation you need.

Les parasols sont reliés par des gouttières et les bâches latérales par des rabats en velcro.  
Les volants inférieurs doivent être laissés pour sauvegarder les irrégularités du terrain, le cas échéant.  
Nous fabriquons des mesures spéciales pour les adapter à l'installation dont vous avez besoin.

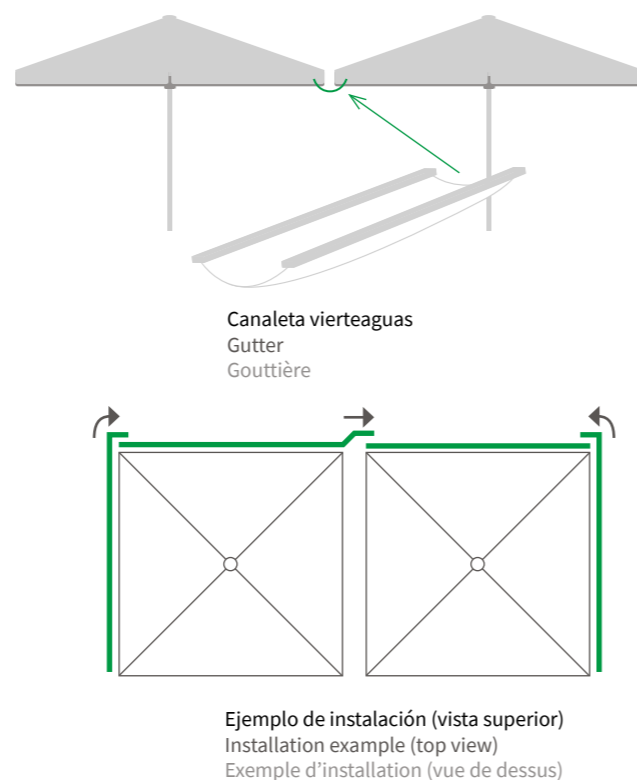

## Sin marcos laterales / Without side frames/ Sans cadres latéraux

Máximo transparente de ancho con velcro para las solapas.  
Maximum width transparent with velcro for the flaps.  
Largeur maximale transparente avec velcro pour les rabats.

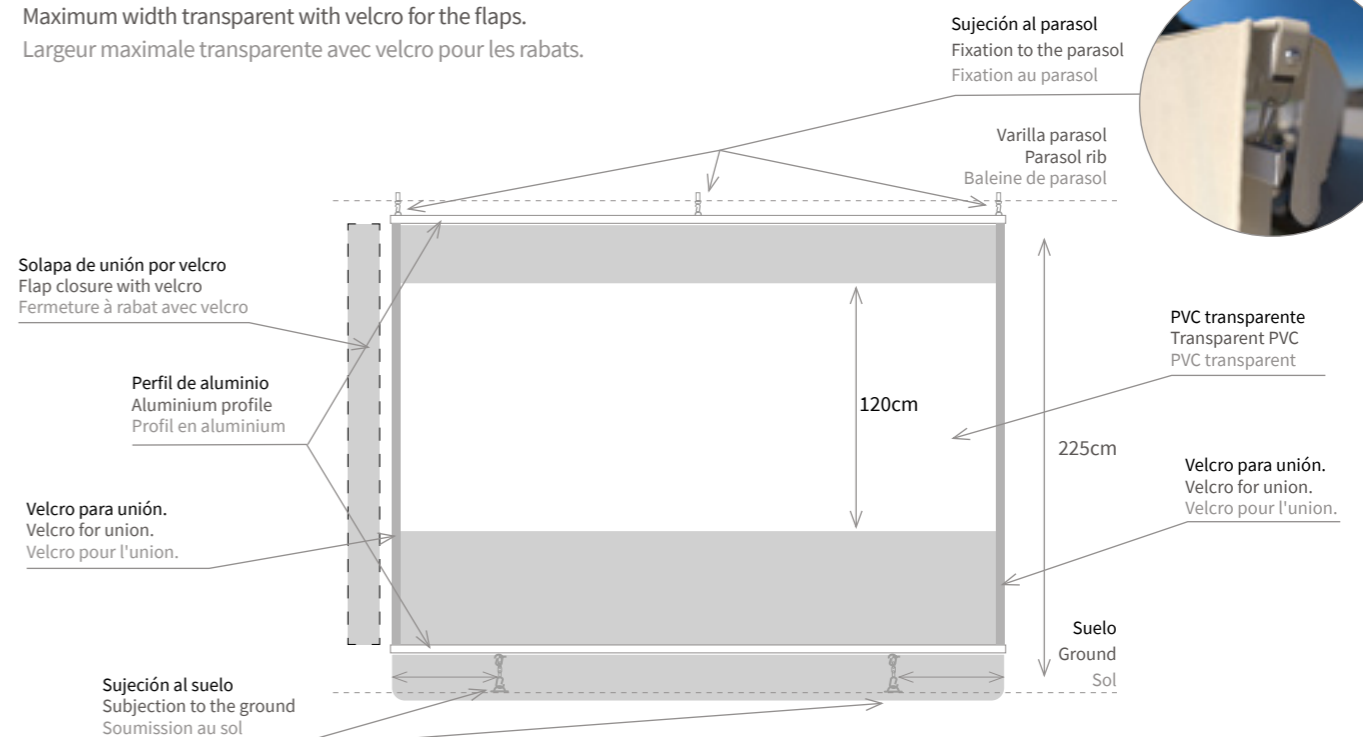

# Separadores

## Fences / Séparateurs

### Textiles

Base peana de acero inoxidable de 7,5kg y ø36cm.  
Mástil de acero inoxidable de 75cm de altura y ø5cm.  
Barras de acero inoxidable con clips de sujeción.

Stainless steel base of 7,5kg and ø36cm.  
Pole of 75cm high and ø5cm in stainless steel.  
Stainless steel cross beams with clips.

Base en acier inoxydable de 7,5kg et ø36cm.  
Mât en acier inoxydable de ø5cm et une hauteur de 75cm.  
Barres en acier inoxydable avec crochets.

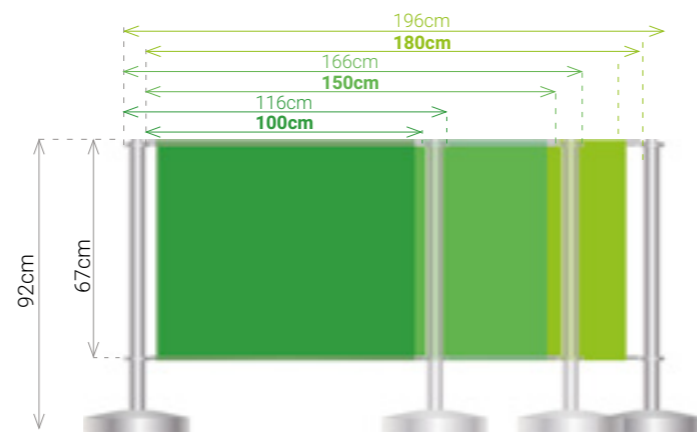
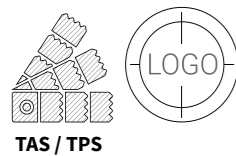

### Maceteros / Planter / Planteur

Fabricados en chapa de acero de 1,5mm.  
Acabados con pintura oxiron color gris oscuro.  
Cristal laminado de 4+4mm.  
Guías para el cristal de 15x15x1,5mm.  
Sistema de desagüe.  
Pies de soporte para fijar al suelo.

Made of 1,5mm steel sheet.  
Dark gray finish with oxiron paint.  
4+4mm laminated glass.  
15x15x1,5mm guides for glass.  
Drainage system.  
Support for ground fixing.

Fait en tôle d'acier de 1,5mm.  
Peinture oxiron gris foncé.  
Verre feuilleté 4+4.  
Rails pour verre de 15x15x1,5mm.  
Système de drainage.  
Support pour fixer au sol.

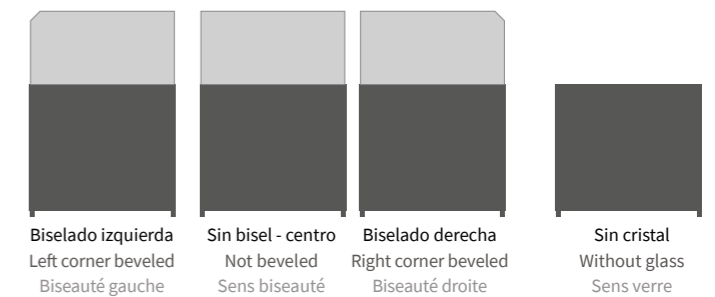
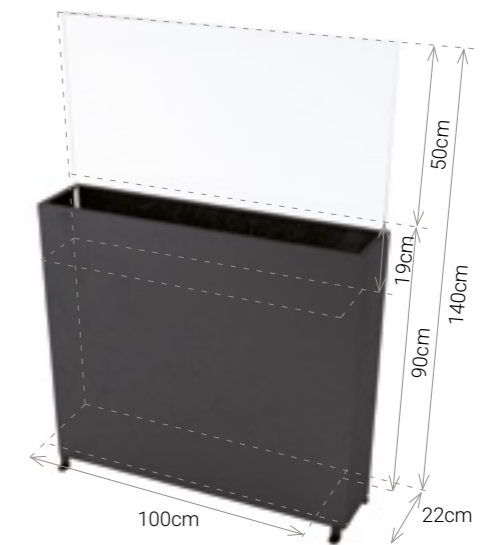

# Estructura

## Frame / Monture

### Acabado color sólido Solid color finish Finissage an couleur solide

Elija entre más de 200 colores para el acabado de la montura. (Consulte carta de colores RAL). Este acabado está disponible solo para las monturas de aluminio y tiene un incremento sobre el precio de tarifa del parasol.

Choose from a variety of more than 200 colors for the frames. (Consult RAL colors). Frame colors are only available for aluminium frames. Surcharge indicated on price list.

Choisissez entre plus de 200 couleurs pour la structure. (Consulte la carte RAL). Les couleurs pour la structure sont seulement disponibles pour les structures en aluminium. Coût supplémentaire indiqué dans la liste de prix.



Para la serie:  
For serie:  
Pour série:

- |                   |                   |
|-------------------|-------------------|
| Estandar          | Elite Plus        |
| Estandar Extra    | Berlín            |
| Elite             | Berlín desplazado |
| Elite telescopico | Palma             |
| Elite desplazado  | Palma desplazado  |

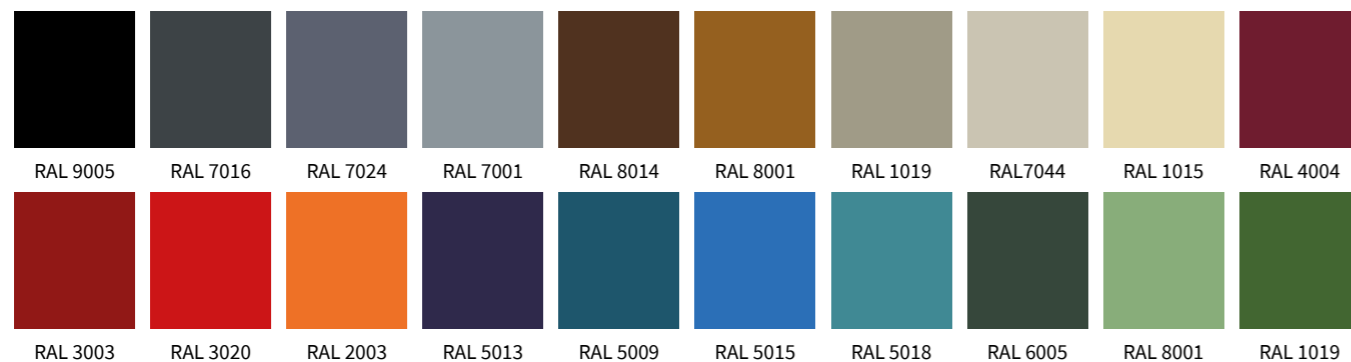

### Acabado imitación madera Wood-like finish Finissage imitation bois

Acabado de alta calidad con textura y color imitación madera. Este acabado tiene las mismas cualidades, resistencia y durabilidad del aluminio y la estética, textura y color de la madera.

High quality finish with wood imitation feel and color. Same strength and durability as aluminium but natural wood looking.

Finition de haute qualité avec texture et couleur imitation bois. Mêmes propriétés, résistance et durabilité que l'aluminium mais avec l'apparence du bois.



Para la serie:  
For serie:  
Pour série:

- |                   |
|-------------------|
| Estandar Extra    |
| Elite             |
| Elite Telescopico |
| Elite Plus        |
| Elite Desplazado  |
| Palma             |
| Palma desplazado  |



# Estampación textil

Textile printing / Estampage textile

Diseñamos o preparamos vuestra propuesta para la estampación textil en los parasoles. Una vez aprobada la propuesta en soporte digital, procedemos con la estampación.

We design or prepare your ideas for the textile printing. Once you approve the proposal in a digital format, we start to print.

Nous concevons ou préparons vos idées pour l'estampage textile sur les parasols. Une fois adoptée votre idée sur support numérique, nous procédons à l'estampage.

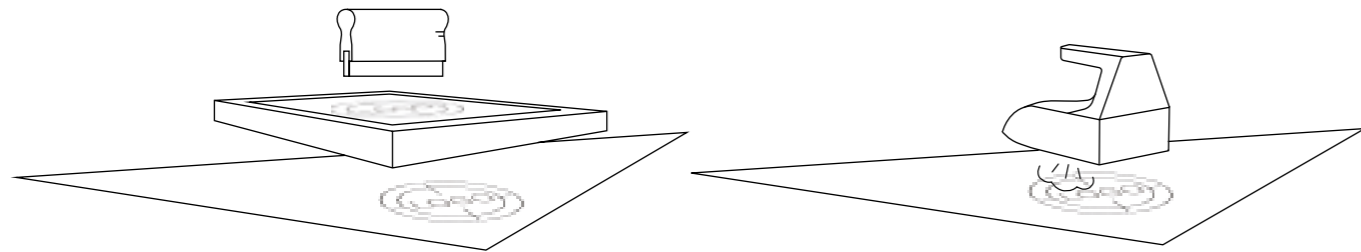
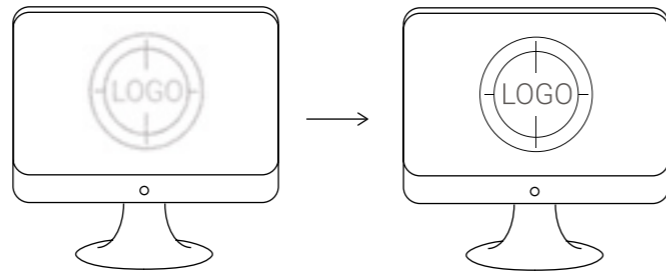

## Serigrafía Silk-screen Sérigraphie

- Se aplica a cualquier tejido.
- Por cada color se utiliza un fotolito y una estampación.
- Máximo 3 tintas.
- It applies to any fabric.
- For each color we use a photolith and a print.
- Maximum 3 inks.
- Applicable à quelconque tissu.
- Pour chaque couleur on utilise un typon et un estampage.
- Maximum 3 encres.

## Vinilo textil Textile vinyl Vinyle textile

- Solo tejido acrílico.
- 1 solo color o CMYK.
- De 1 a 8 estampaciones.
- Medidas hasta 95 x 75cm.
- Only acrylic fabric.
- Only 1 color or CMYK.
- From 1 to 8 prints.
- Measures up to 95 x 75cm.
- Seulement tissu acrylique.
- 1 seule couleur ou CMYK.
- De 1 à 8 estampages.
- Mesures jusqu'à 95 x 75cm.

# Faldón luminoso

Lighting volant / Volant lumineux

Con el faldón luminoso, su logo será el más vistoso, sobre todo por la noche. Funciona con una placa de tecnología LED muy fina y ligera insertada en el faldón y un transformador de 24V que le permite un buen flujo lumínico para que sea visible a cortas y largas distancias. Para cerrar el parasol hay que quitar el faldón, que se monta fácilmente con velcro.

The luminous volant will make your logo visible and attractive, especially at night. We use a very thin and light LED technology plate inserted into the volant with a 24V transformer that will allow a good light flow so that the logo will be visible at short and long distance. To close the parasol you have to remove the volant, which is easily mounted with Velcro.

Le volant lumineux rendra votre logo visible et attractif, surtout la nuit. Nous utilisons une plaque de technologie LED très fine et légère insérée dans le volant avec un transformateur 24V qui permet un bon flux lumineux afin que le logo soit visible à courte et longue distance. Pour fermer le parasol, vous devez retirer le volant, qui se monte facilement avec du velcro.

Rotulación hasta 2 metros de largo  
Lettering up to 2 metres long  
Lettrage jusqu'à 2 mètres de long

**Para la serie:**  
**For serie:**  
**Pour série:**

- Estandar Extra
- Elite
- Elite Telescopico
- Elite Plus
- Elite desplazado
- Palma
- Palma desplazado
- Berlin
- Berlin desplazado



# Tejidos

## Fabric / Tissu

### ✓ Basicos / basic

No se aplica ningún incremento en el precio.  
No price increase applied.  
Aucune augmentation de prix appliquée.

### Poli-cot

ref TPA - 180g/m<sup>2</sup>

Composición 30% poliéster / 70% algodón.  
Evita la formación de malos olores y previene el crecimiento de hongos y no provoca reacciones alérgicas. Al presentar un alto porcentaje de algodón, fibra natural, absorbe el calor con mayor eficacia que los tejidos sintéticos.



Crudo

Composition 30% polyester / 70% cotton.  
It prevents the formation of bad odors and prevents the growth of fungi and does not cause allergic reactions. It absorbs heat more effectively than synthetic fabrics because have a natural fiber.

Composition 30% polyester / 70% coton.  
Il empêche la formation de mauvaises odeurs et empêche la croissance de champignons et ne provoque pas de réactions allergiques.  
En présentant un pourcentage élevé de coton, de fibres naturelles, il absorbe la chaleur plus efficacement que les tissus synthétiques.

### Lona

ref TOP - 200g/m<sup>2</sup>

Alta solidez de colores/Resistencia a las manchas/ 100% Producido en Europa/  
Eco friendly/100% Reciclable/Protección máxima de la piel/ Bloquea más del 97% de los UV.  
**Para otros colores consultar.**

High colour fastness/Resistance to stains/  
100% Produced in Europe/Eco friendly/  
100% Recyclable/Maximum skin protection/  
Blocks over 97% of UV.  
**For other colors, please contact us.**

Grande solidité des couleurs/Résistance aux taches/100% Produit en Europe/Écologique/  
100% Recyclable/Protection maximale de la peau/Bloque plus de 97% des UV.  
**Pour d'autres couleurs, veuillez nous contacter.**



### PVC

ref TPS 400-500g/m<sup>2</sup>

Larga vida/ Elevada resistencia frente a los rayos UV/ Colores sólidos/ Impermeabilidad/ Tratamiento anti-hongos para entornos marinos/ Fácil limpieza. **Opcional Fire Retardant.**

Long life/High UV resistance/Solid colours /Waterproof/Anti-fungal treatment for marine environments/Easy cleaning. **Fire Retardant optional.**

Longue durée de vie/Haute résistance aux UV/ Couleurs solides/Imperméable/Traitement antifongique pour environnements marins/Nettoyage. **Ignifuge en option.**



IMPERMEABLE  
WATERPROFF  
IMPERMÉABLE



OPCIONAL:  
OPTIONAL:  
OPTIONEL:



IGNIFUGO  
FIREPROFF  
IGNIFUGER



### PVC Screen

ref TSS 530g/m<sup>2</sup>

Gran protección térmica / Transpirable / Tejido ignifugo con certificado Flame Retardant / No es impermeable.

Great thermal protection / Breathable / Fire retardant fabric with certificate /Is not waterproof.

Excellente protection thermique / Respirant / Tissu ignifuge avec certificat /N'est pas étanche.



TRANSPIRABLE  
BREATHABLE  
RESPIRANT



IGNIFUGO  
FIREPROFF  
IGNIFUGER

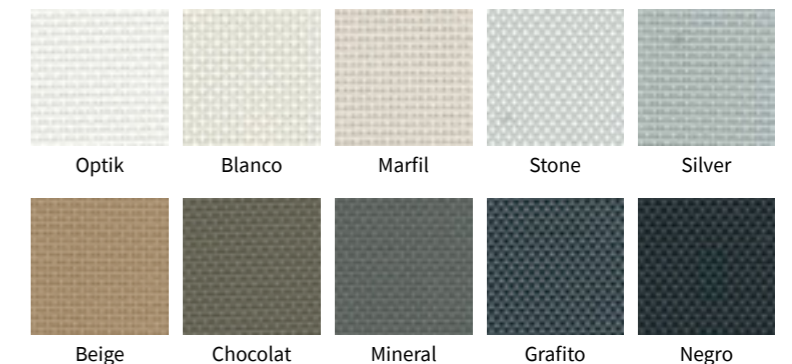

### LOOP

ref TLP 300g/m<sup>2</sup>

Tejido sostenible producido de residuos textiles. Rápido secado/Transpirante/Columna de agua de 300/Repelente al agua/Máxima resistencia/ Antibacteriano/Antimanchas/Anti-UVI/Doble cara/Producción respetuosa/Fácil mantenimiento.

Sustainable fabric produced with textile waste. Fast drying/Breathable/Water column 300/Water repellent/Maximum resistance/Anti-bacterial/Anti-stain/Anti-UVI/Double-sided/Respectful production/Easy maintenance.

Sustainable fabric produced with textile waste. Séchage rapide/Respirant/Colonne d'eau 300/ Hydrofuge/Résistance maximale/Anti-Bactérien/ Anti-Taches/Anti-UVI/Double face/Production respectueuse/Entretien facile.

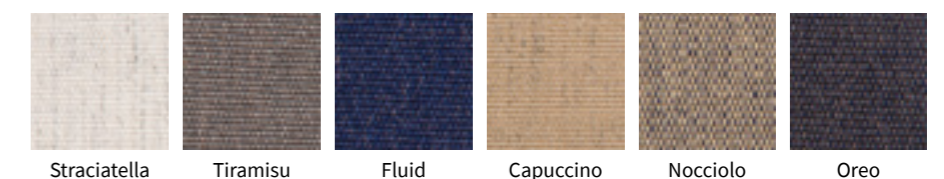

REPELENTE AL AGUA  
WATER-REPELLENT  
HYDROFUGE

# Tejidos

## Fabric / Tissu

### Acrilico / Acrylic / Acrylique

ref **TAS** - 300g/m<sup>2</sup>

Rápido secado/Transpirante/Columna de agua de 300/Repelente al agua/Máxima resistencia/Antibacteriano/Antimanchas/Anti-UVI/Doble cara/Producción respetuosa/Fácil mantenimiento.

Fast drying/Breathable/Water column 300/Water repellent/Maximum resistance/Anti-bacterial/Anti-stain/Anti-UVI/Double-sided/Respectful production/Easy maintenance.

Séchage rapide/Respirant/Colonne d'eau 300/Hydrofuge/Résistance maximale/Anti-Bactérien/Anti-Taches/Anti-UVI/Double face/Production respectueuse/Entretien facile.



REPELENTE AL AGUA  
WATER-REPELLENT  
HYDROFUGE

#### Basicos

No se aplica ningún incremento en el precio.  
No price increase applied.  
Aucune augmentation de prix appliquée.

#### Resinado / Resin coat / Resiné

Posibilidad de acabado impermeable.  
Columna de agua 1000.  
Addition waterproof finish.  
Water column 1000.  
Finition imperméable complémentaire.  
Colonne d'eau 1000.

#### Green®

Tejido Green® (by Sauleda & Pureti). Los tejidos tratados con este acabado limpian y purifican el aire mediante la fotocatalisis, eliminando contaminantes como NOx, SOx y COVs. Los tejidos Green® tienen además un efecto autolimpiante y de reducción de los mohos.

Green® fabric (by Sauleda & Pureti). With this treatment, fabrics will clean and purify the air through photocatalysis, removing contaminants such as NOx, SOx and VOCs. Green® fabrics also have a self-cleaning and mold-reducing effect.

Tissu Green® (par Sauleda & Pureti). Avec ce traitement, les tissus nettoient et purifient l'air par photocatalyse, éliminant les contaminants tels que les NOx, les SOx et les COV. Les tissus Green® ont également un effet autonettoyant et réducteur de moisissure.

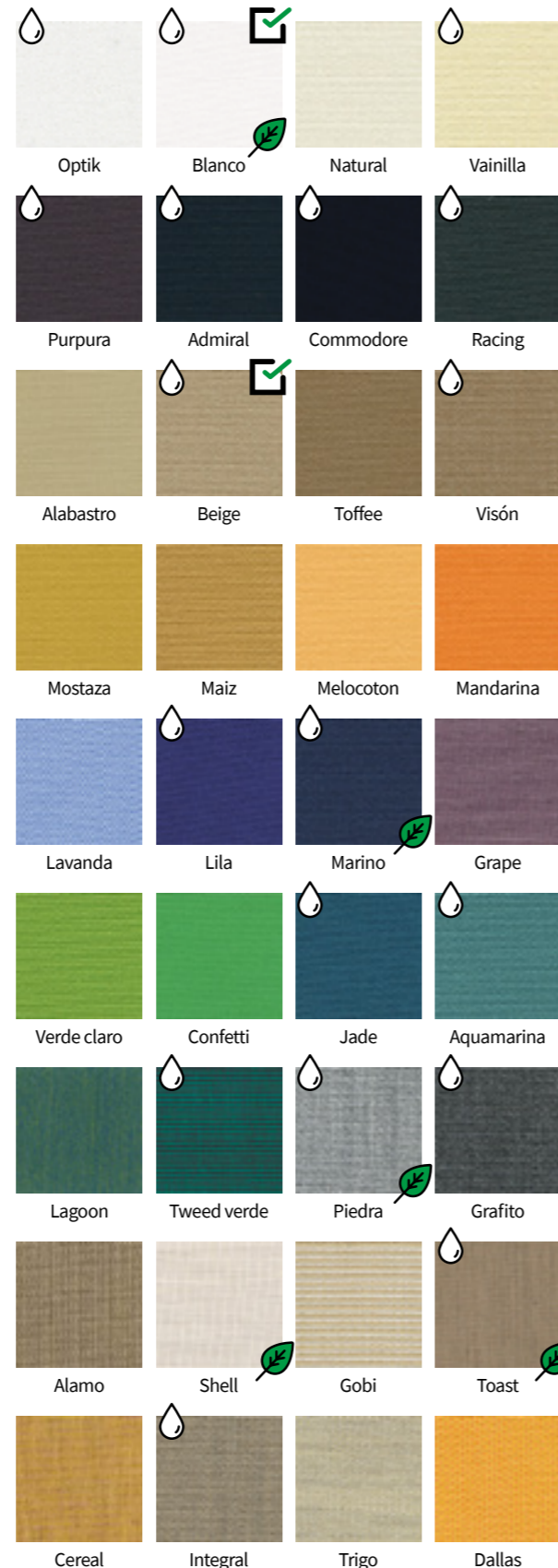

PARAGUAS CARBALLO  
C/ de la Torre, 98  
15002 A Coruña  
Telf. 981 204 609  
[www.paraguascarballo.com](http://www.paraguascarballo.com)  
[info@paraguascarballo.com](mailto:info@paraguascarballo.com)